



FACADE **ONE**  
INTERNATIONAL

Innovative Façade Solutions

# INTRODUCTION

---

- Façade India Group Company
- FITI Panel Member with NBC
- 15 Yrs Testing – Design – System
- 150 + Satisfied Clients & Exports
- DNA – Innovation & Differentiation
- Patents / IPR – Many Patents & IPR
- Product Portfolio - 92% For Building facades

# INTERNATIONAL PRESENCE

---

- Façade One International FZ LLC Dubai
- Façade One International Swiss
- Façade One International USA
- Representative Newzeland
- Representative Australia

# VISION

---



- We aspire to be among leading International companies in façade and fenestration products through innovative, robust and sustainable design solutions.
- We continue to develop a culture of innovation in the organization and innovate architectural concepts and products of next generation to convert architectural vision in to reality.



# MISSION

---



- Year 2029 to Become 1.5 Billion \$ Group
- Company shall provide freedom to Innovate & perform, training to enhance skills and competence of employees.

# INFRASTRUCTURE INDIA

---



- Design office - 12000 sq.ft
- Organization – 100 + Designers and Support functions
- R & D center spread over 150,000 sq.ft land
- Asia's largest Test Laboratory

# DESIGN SOFTWARE

---

- Autocad version 2017 ( 2D / 3D )
- Athena software – Curtain wall design
- Staad pro V8i – Structural analysis
- S J MEPLA – Glass design
- REVIT – Beam modeling
- ECOTECT – Building physics
- FLIXO Thermal analysis
- 3D Max & Lumion – 3D Modeling & Rendering
- Orgadata – Estimation , Optimization & Fabrication
- Rhino + Grass hopper – Free form designs
  
- 3D Printer – 3D Object printing

# PRODUCT MANUFACTURED

---

- India
- Dubai - GULFEX

# PREMIUM PRODUCTS

---

- AS 300 - ENTRANCE GLAZING
- ENERGY EFFICIENT CURTAIN WALLS &
- DOUBLE SKIN
- BOMB BLAST RESISTANT FAÇADE -15 & 120 Kpa
- SWISSCLAD WALL CALDDING FIRE CLASS A1
- DYNAMIC FACADES
- PANORAMA SLIDING WINDOW & CASEMENTS
- ARCHITECTURAL LOUVERS
- SEAMLESS RAILING & BALUSTRADE RAILING
- SWISS SCREEN – 3D SCREEN

# ALUSLEEK ENTRANCE GLAZING

---

Innovation to Unique Lobby Entrances

## ALUSLEEK ENTRANCE GLAZING

---



FACADE ONE  
INTERNATIONAL



ENTRANCE GLAZING 8 m HEIGHT





## SLEEK CAP

---



FACADE ONE  
INTERNATIONAL

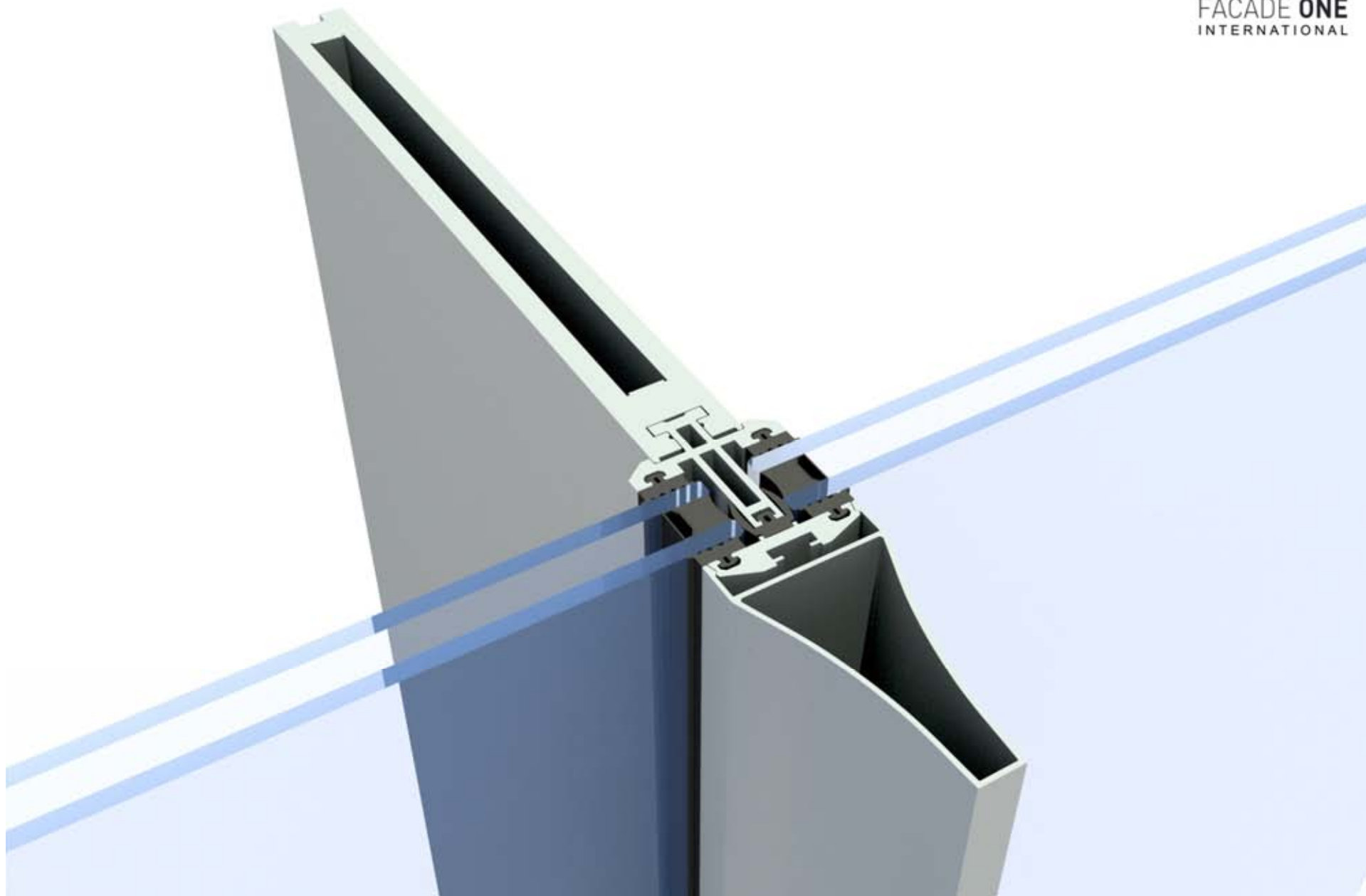

ENTRANCE GLAZING 12 mtr HEIGHT



FACADE ONE  
INTERNATIONAL



## TOGGLE FIXING

---



FACADE ONE  
INTERNATIONAL

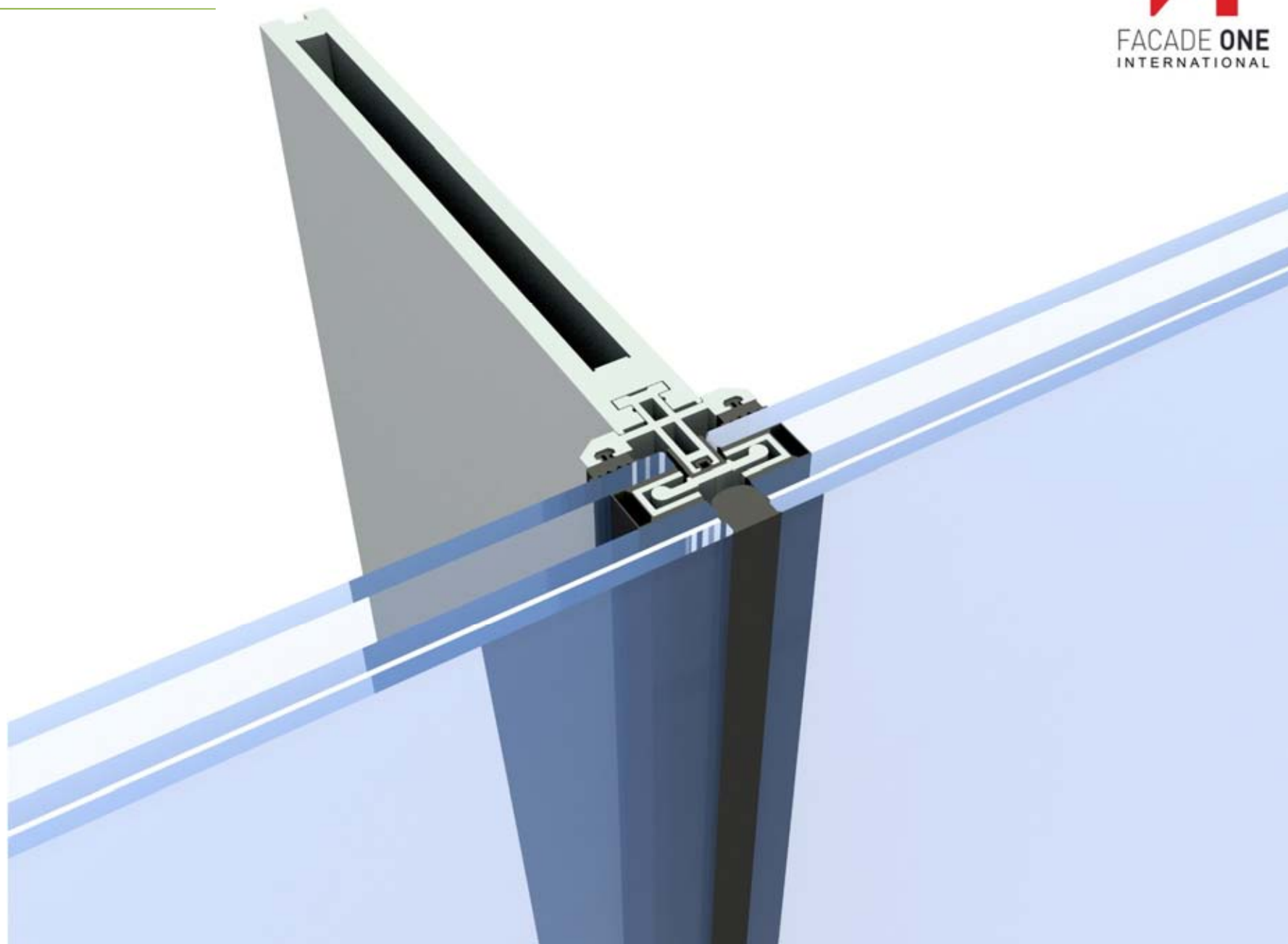



## ALUSLEEK ENTRANCE GLAZING

---

19m Tall Entrance without any steel  
intermediate support

## COMPRESSION PATCH

---



FACADE ONE  
INTERNATIONAL

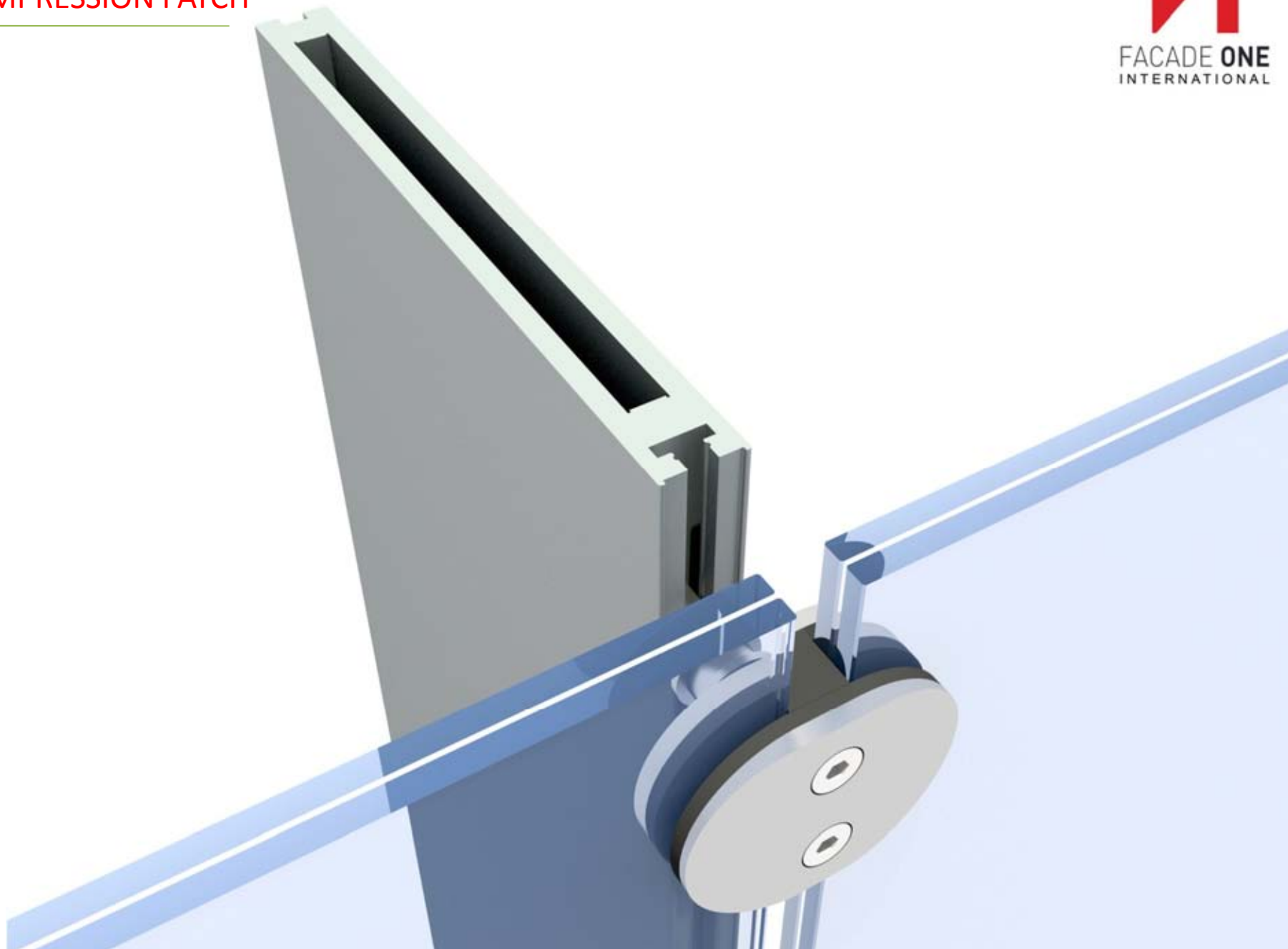



**ALUSLEEK** ENTRANCE GLAZING – 16.6m Entrance with Canopy Supported



**FACADE ONE**  
INTERNATIONAL



## TAPERED PROFILE 4070500

---



FACADE **ONE**  
INTERNATIONAL

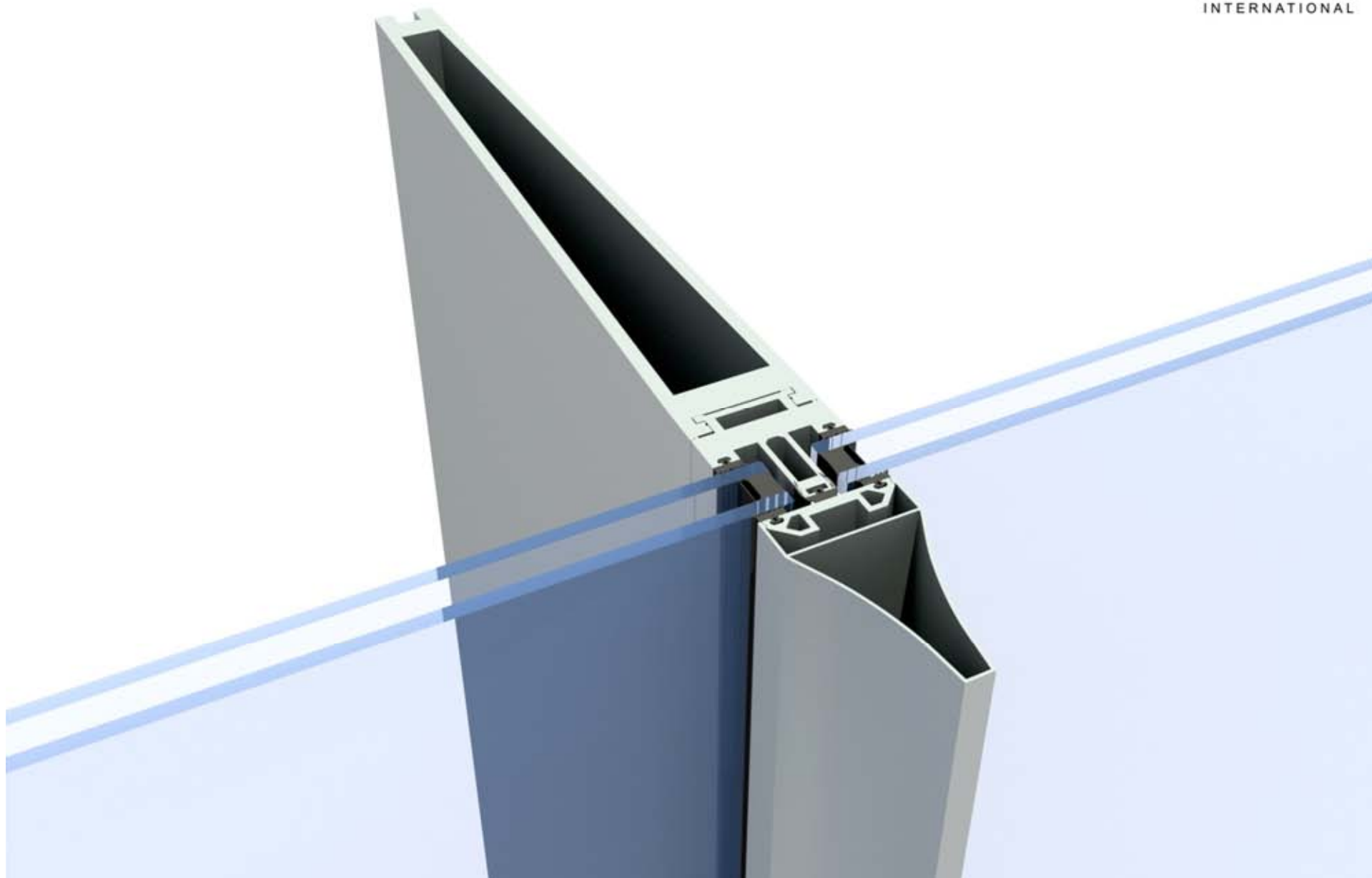



FACADE ONE  
INTERNATIONAL

**ALUSLEEK** ENTRANCE  
GLAZING  
(4070500)

22m Tall Entrance

---



## TAPERED PROFILE

---



FACADE ONE  
INTERNATIONAL

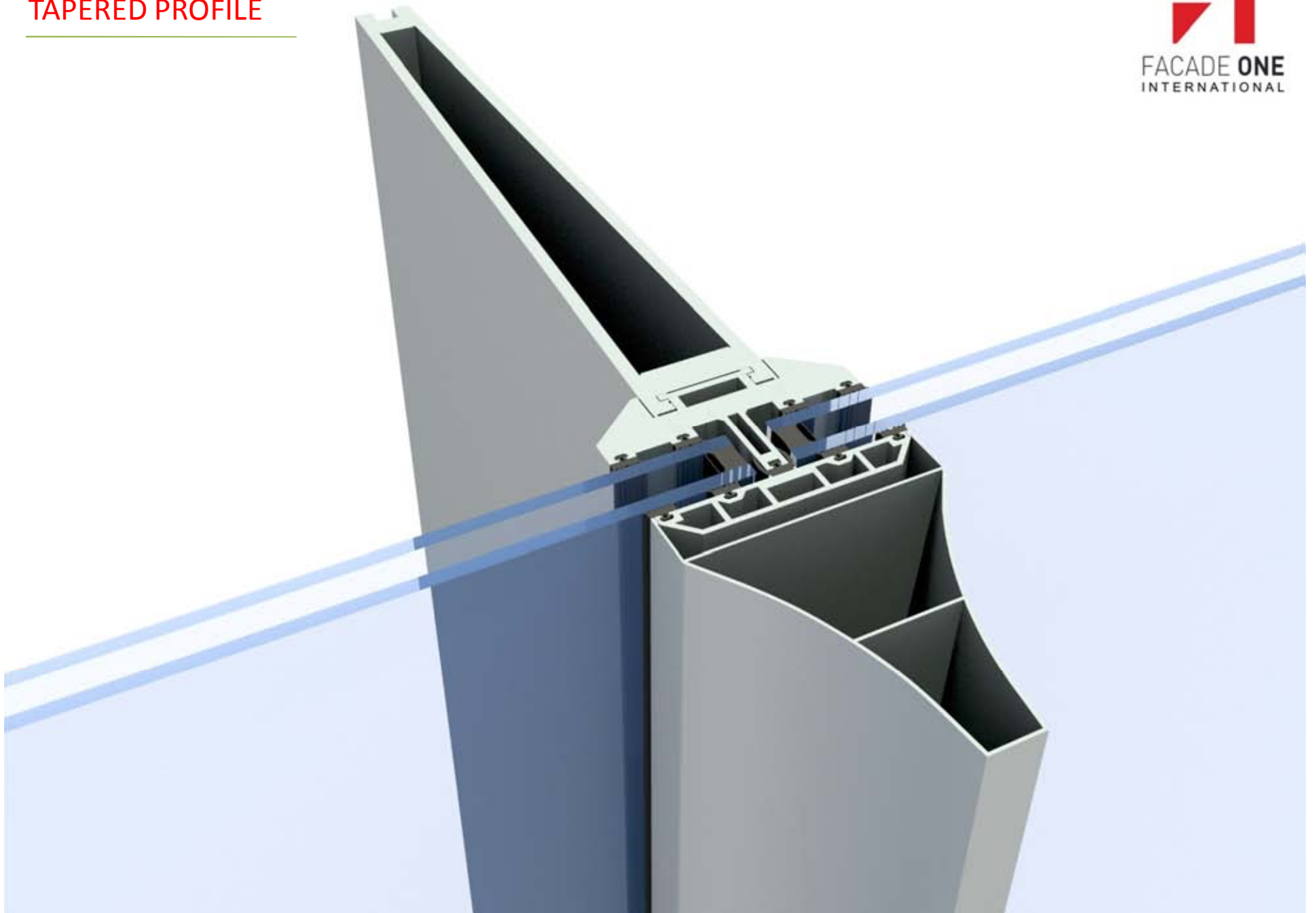

**ALUSLEEK**  
ENTRANCE GLAZING



60m Tall Alusleek Entrance Glazing  
In-Side View

## TAPERED PROFILE with PATCH

---



FACADE ONE  
INTERNATIONAL

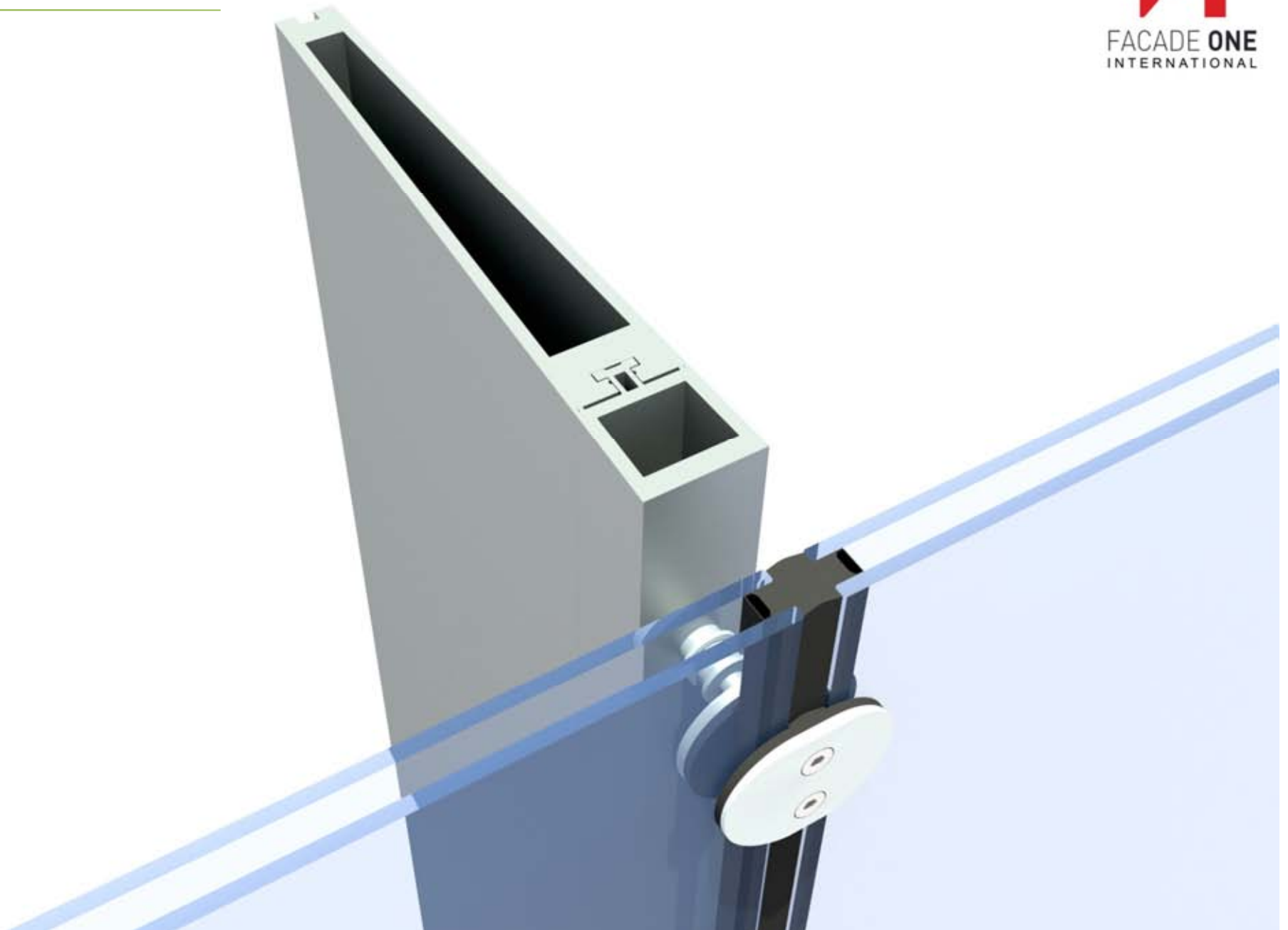

## LED INTEGRATION

---



FACADE ONE  
INTERNATIONAL

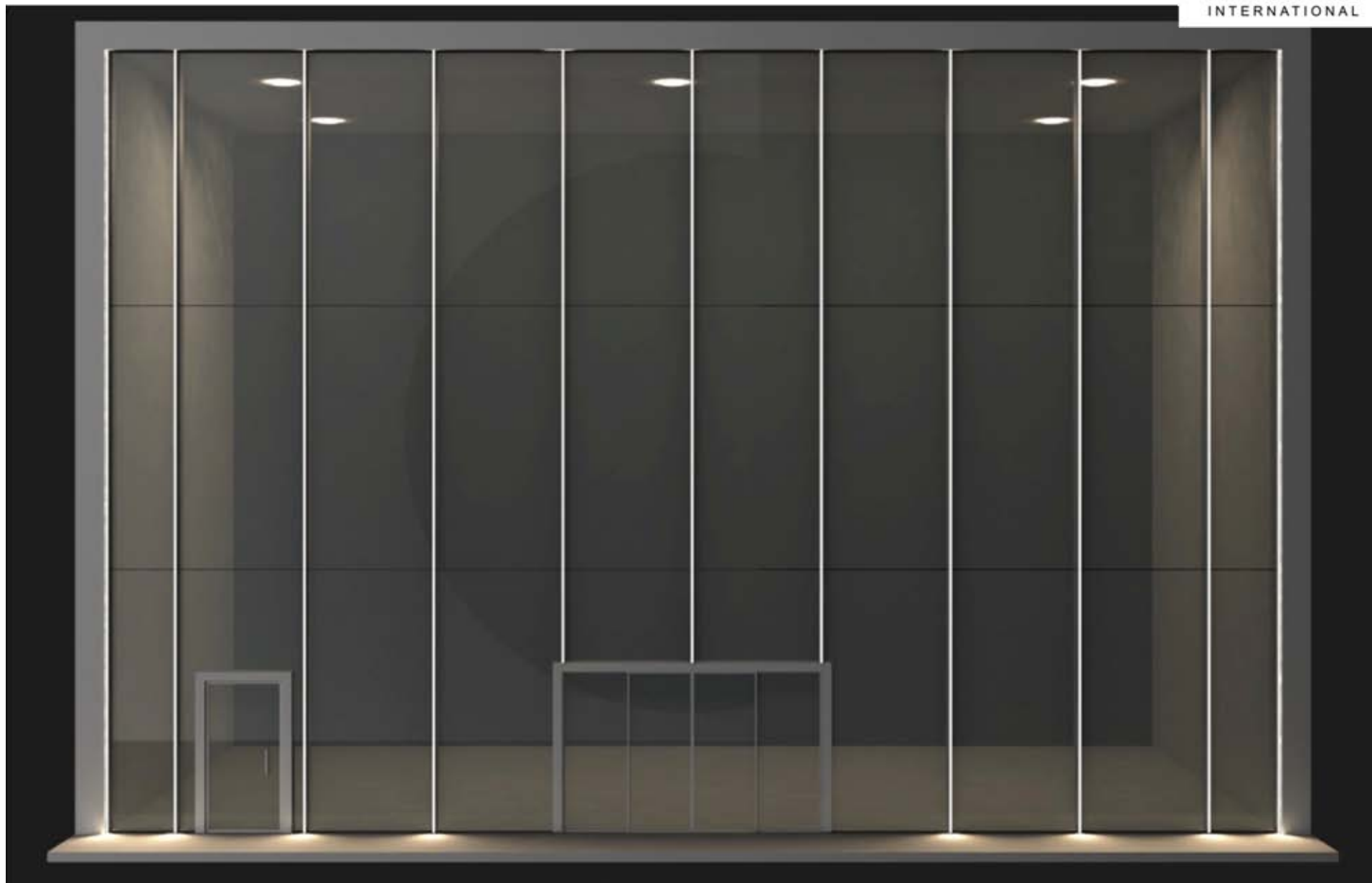

## SLEEK CAP WITH LED



FACADE ONE  
INTERNATIONAL

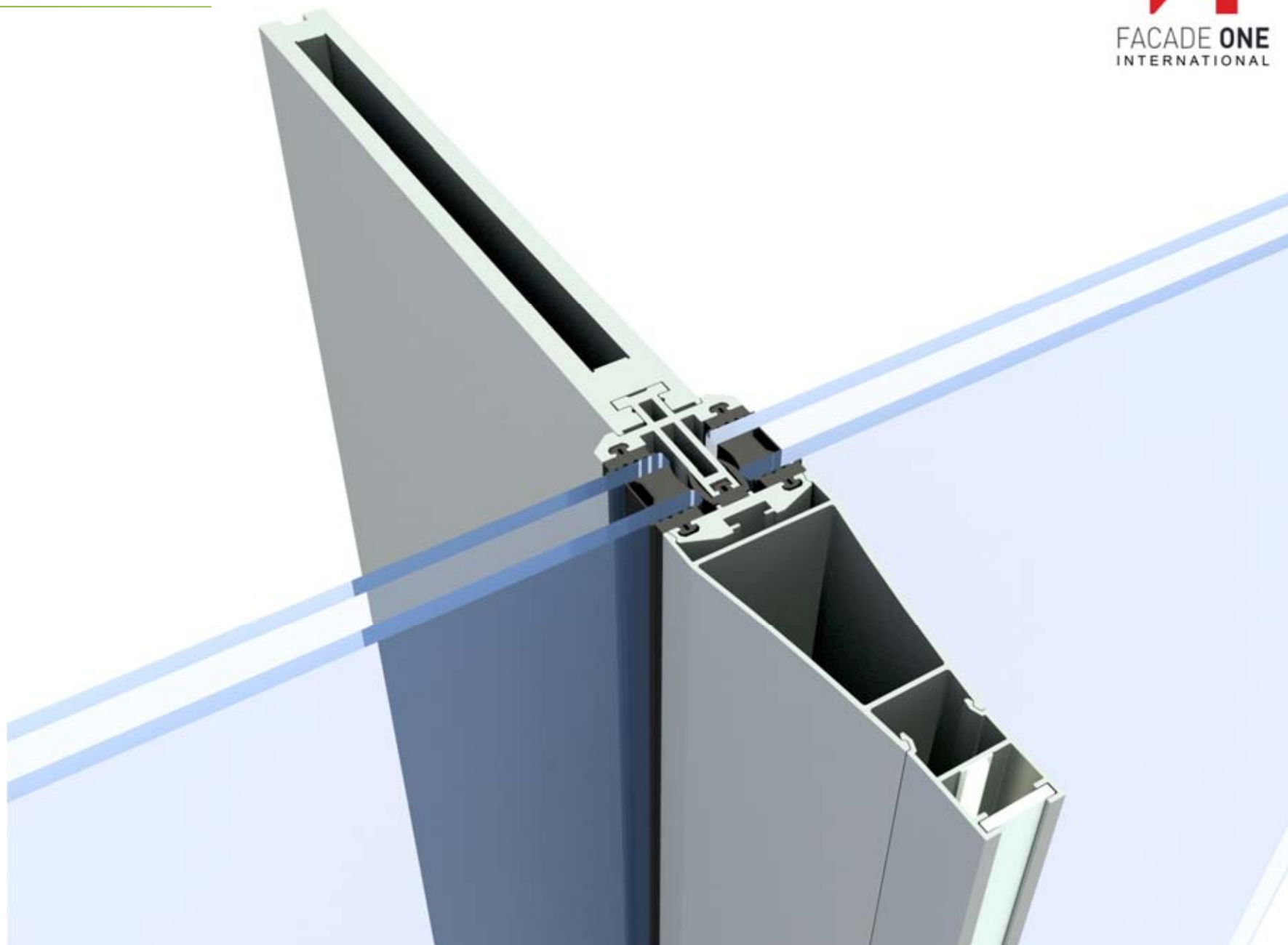



## ENTRANCE GLAZING WITH SCREEN



FACADE ONE  
INTERNATIONAL



## DOUBLE SKIN ENTRANCE

---



FACADE ONE  
INTERNATIONAL

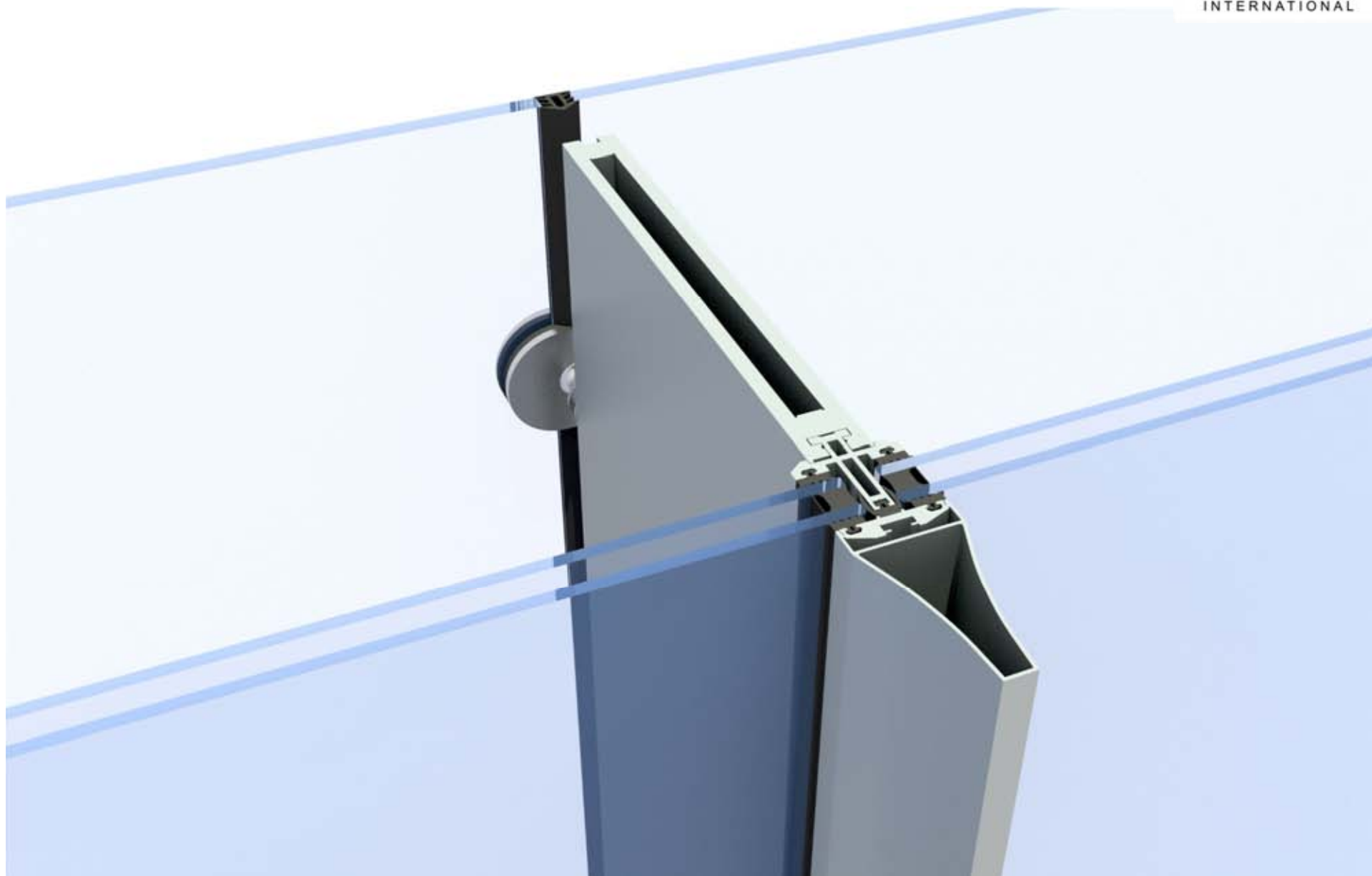



CONCOURSE GLAZING



FACADE ONE  
INTERNATIONAL

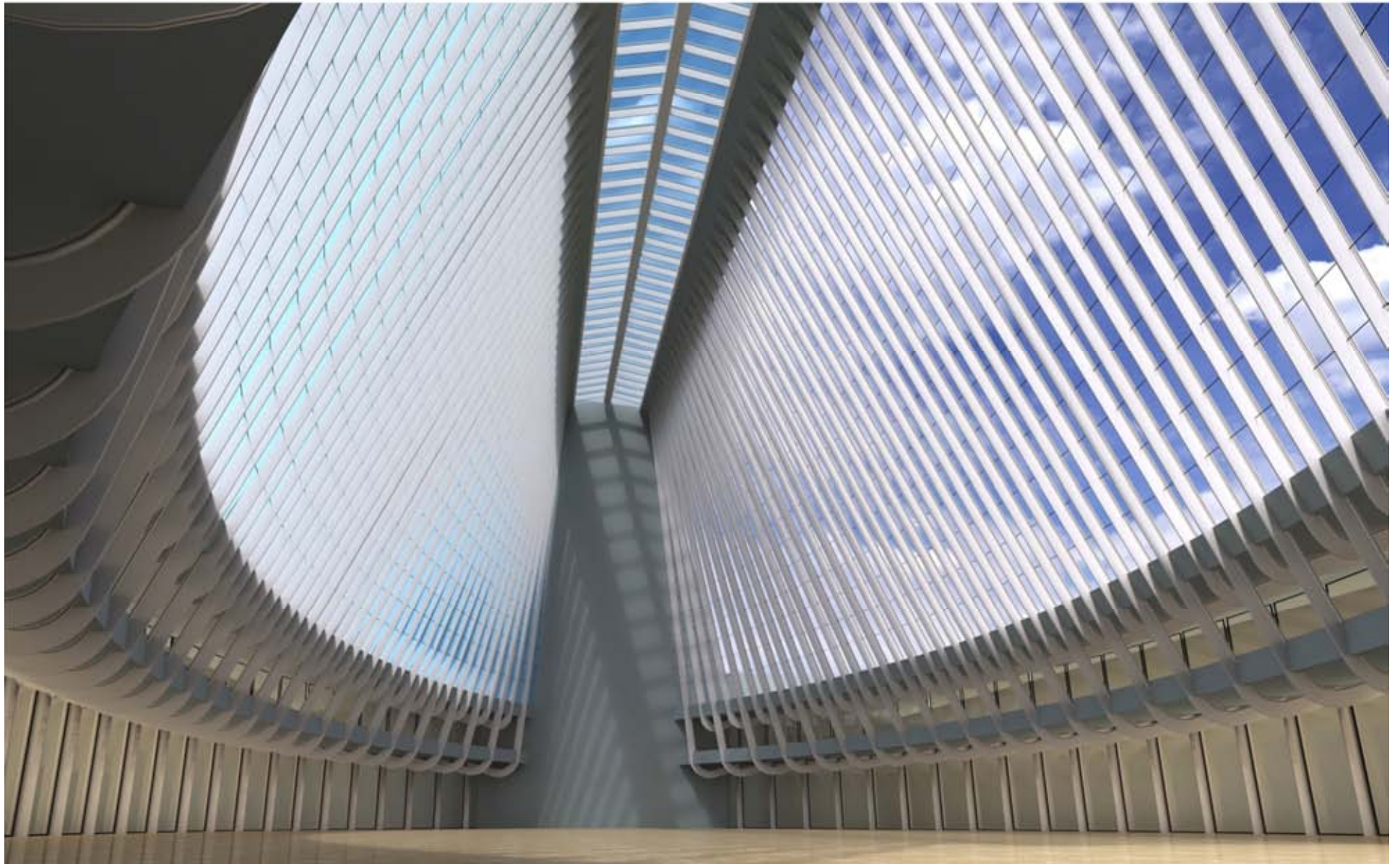



CONCOURSE GLAZING



FACADE ONE  
INTERNATIONAL

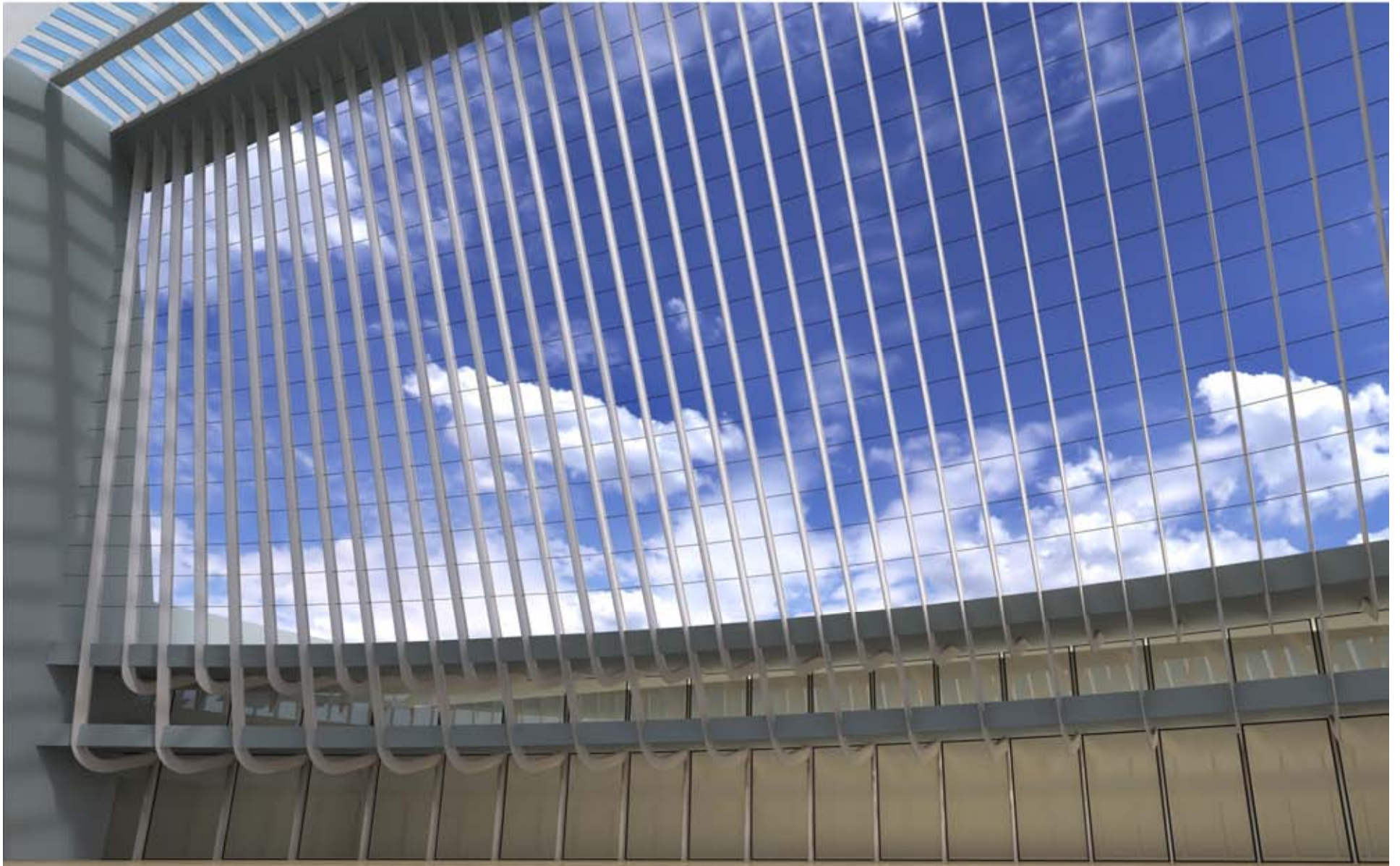

UNIQUE ENTRANCE OF MVMK 70500 FIN



FACADE ONE  
INTERNATIONAL

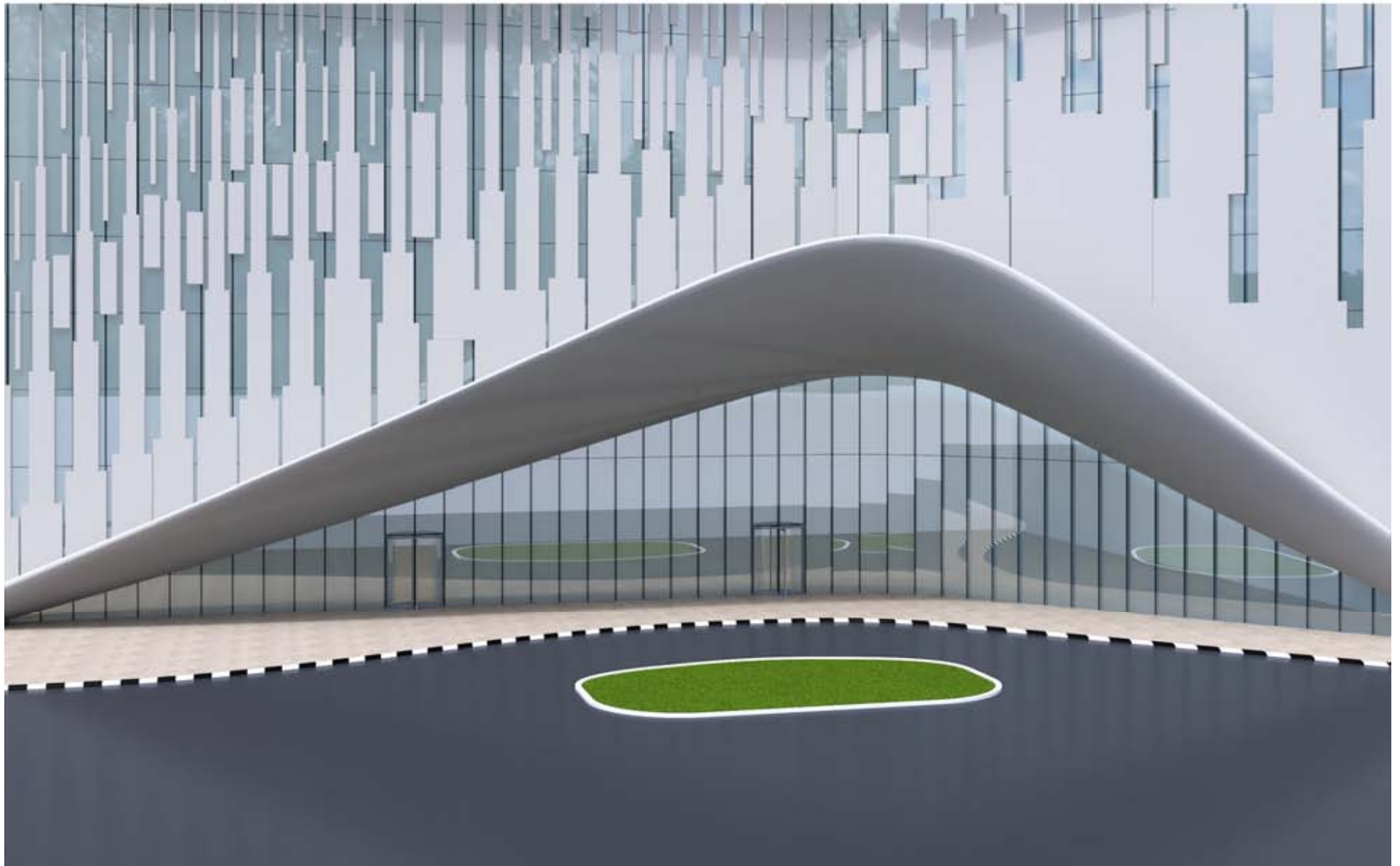

# CURTAIN WALLS

---

Innovation to Unique facades



**GLASS WALL ELEVATION (400-800-2800)**



**FACADE ONE**  
INTERNATIONAL

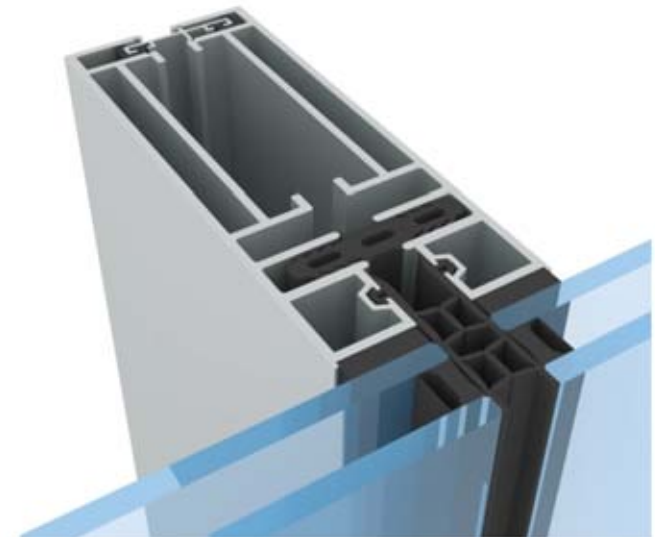

## UNITISED CURTRAIN WALL GLAZING



FACADE ONE  
INTERNATIONAL

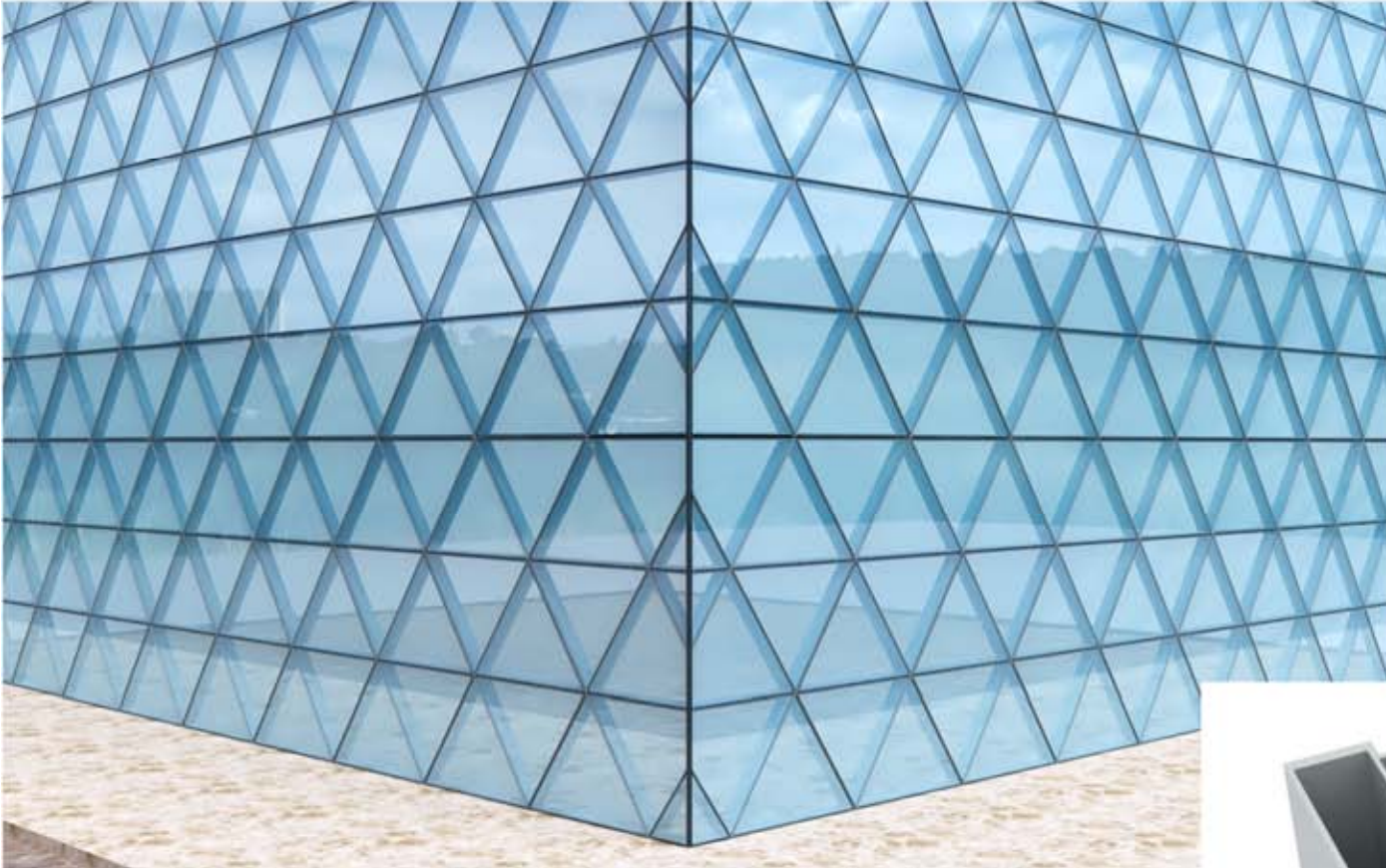



## UNIQUE 3D FACADES

---



FACADE ONE  
INTERNATIONAL

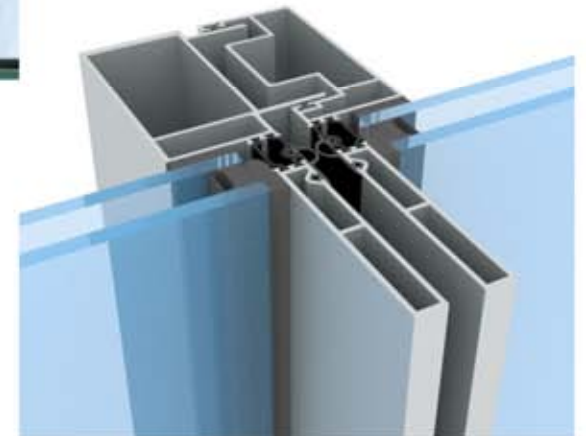

# UNITISED SKEWED WALL

---



FACADE ONE  
INTERNATIONAL

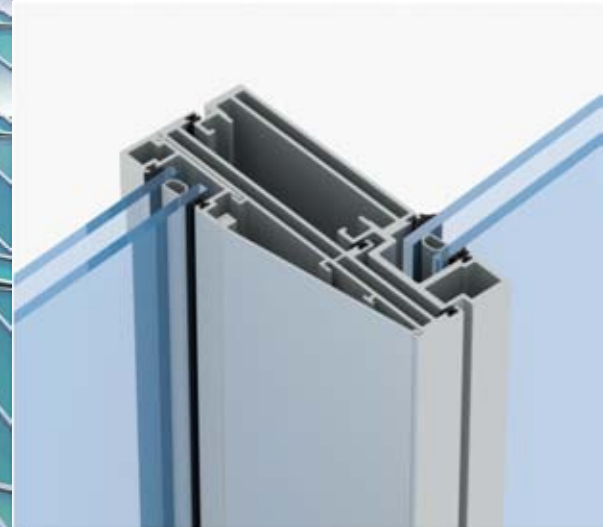
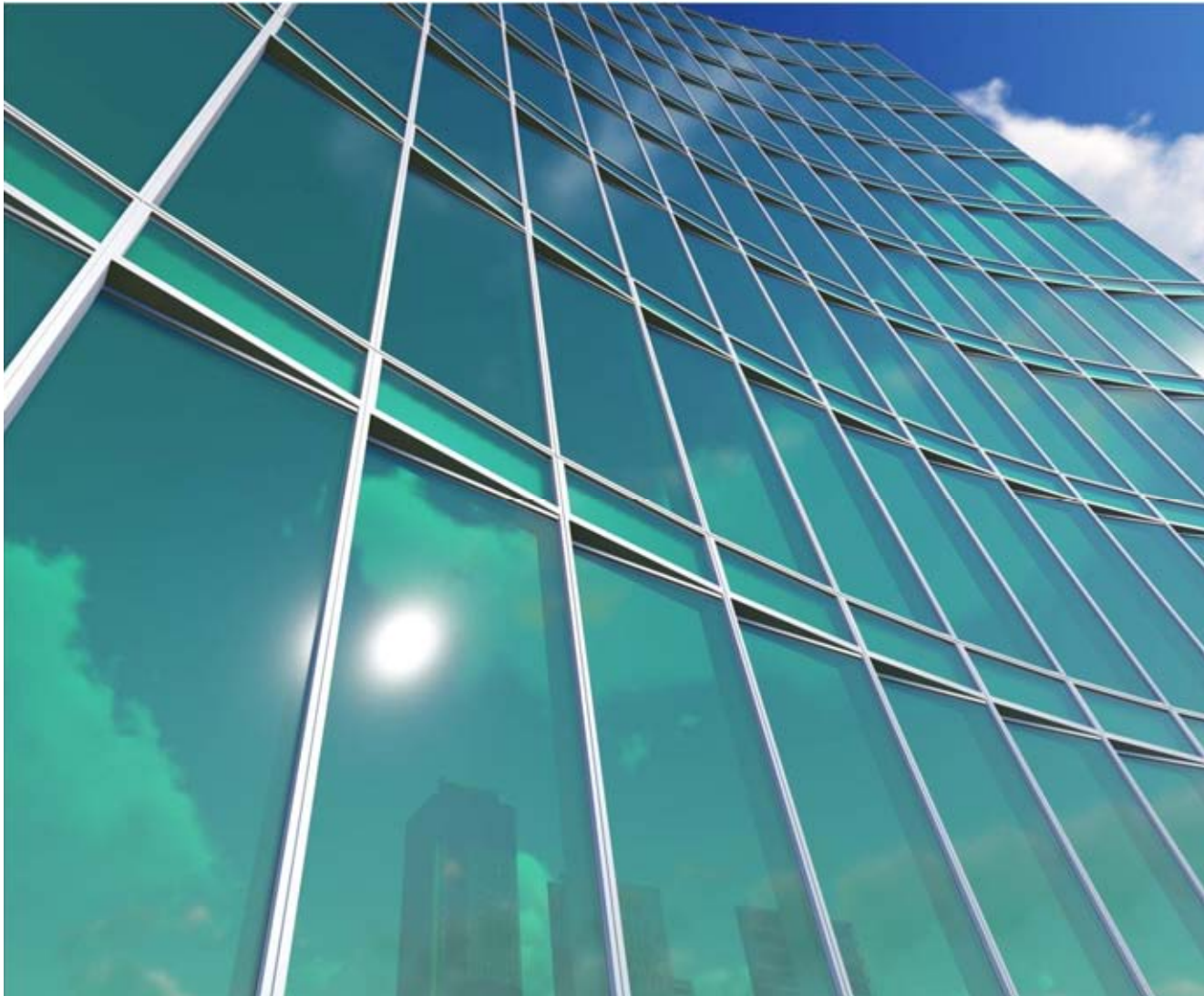



# ARTICULATED GLAZING

---



FACADE ONE  
INTERNATIONAL

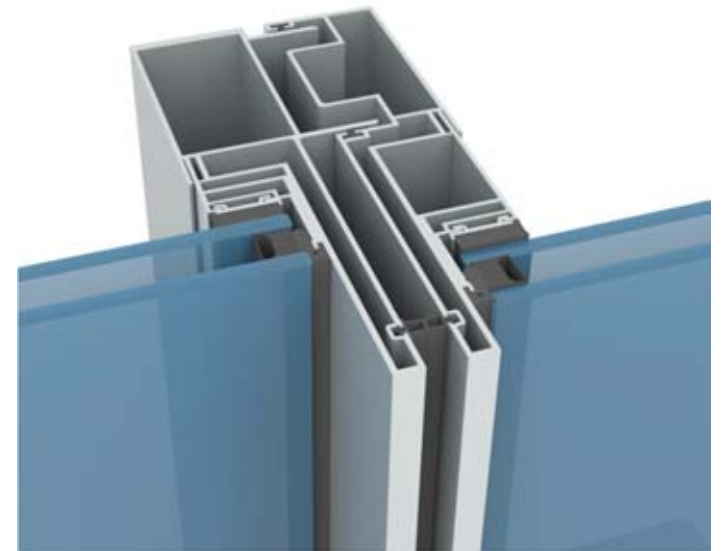



## SLEEK CURTAIN WALL



FACADE ONE  
INTERNATIONAL

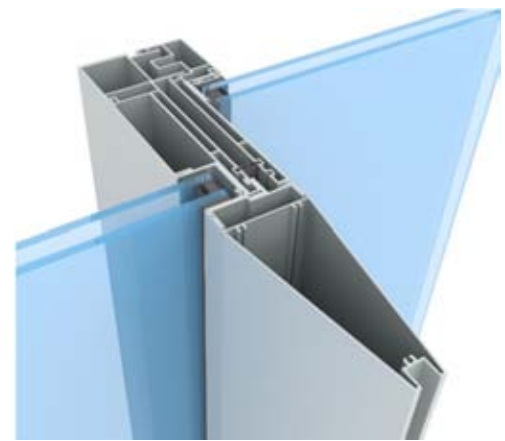
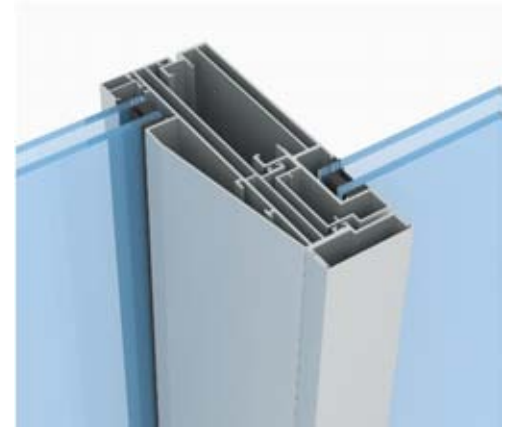

# UNITISED GLASS AND GRANITE WALL



FACADE ONE  
INTERNATIONAL

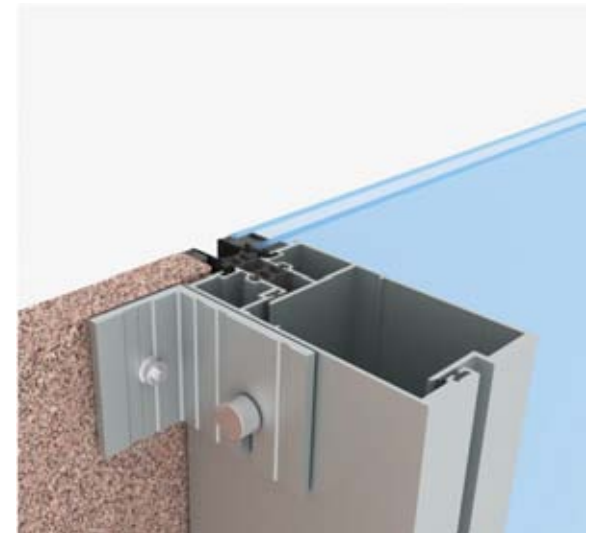
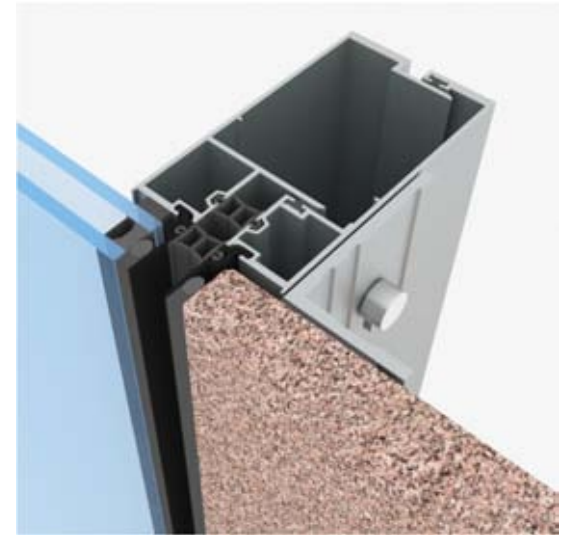



# DIAMOND GLAZING ELEVATION

---



FACADE ONE  
INTERNATIONAL



# DIAMOND GLAZING PART ELEVATION



FACADE ONE  
INTERNATIONAL



# CURTAIN WALLS

---

Innovation to Special facades



## BLAST RESISTANCE UNITISED GLAZING



Design blast resistance system  
to sustain upto **15 KPa**

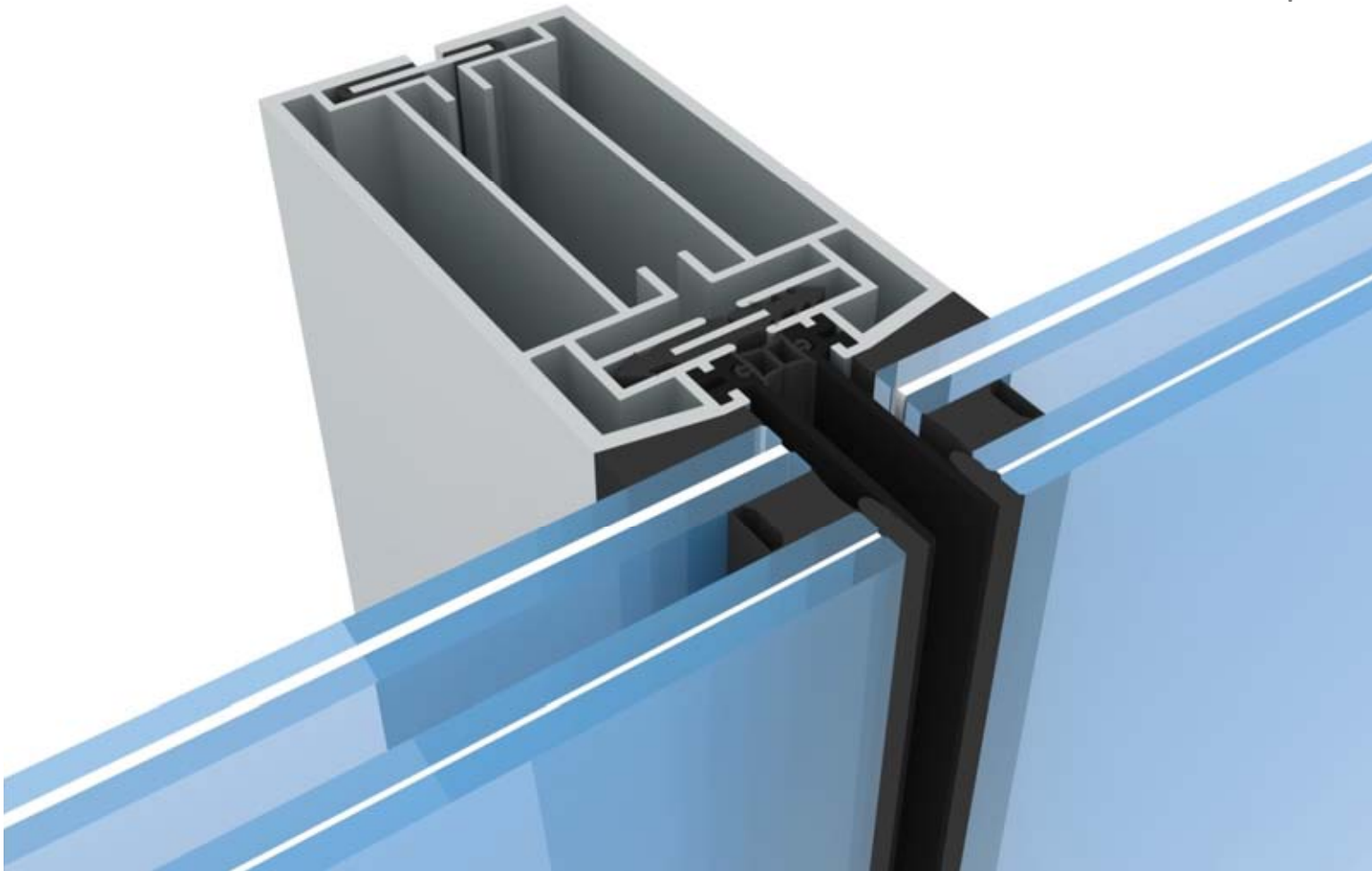

BLAST RESISTANCE LOBBY GLAZING



Blast Resistance **120 KPa**

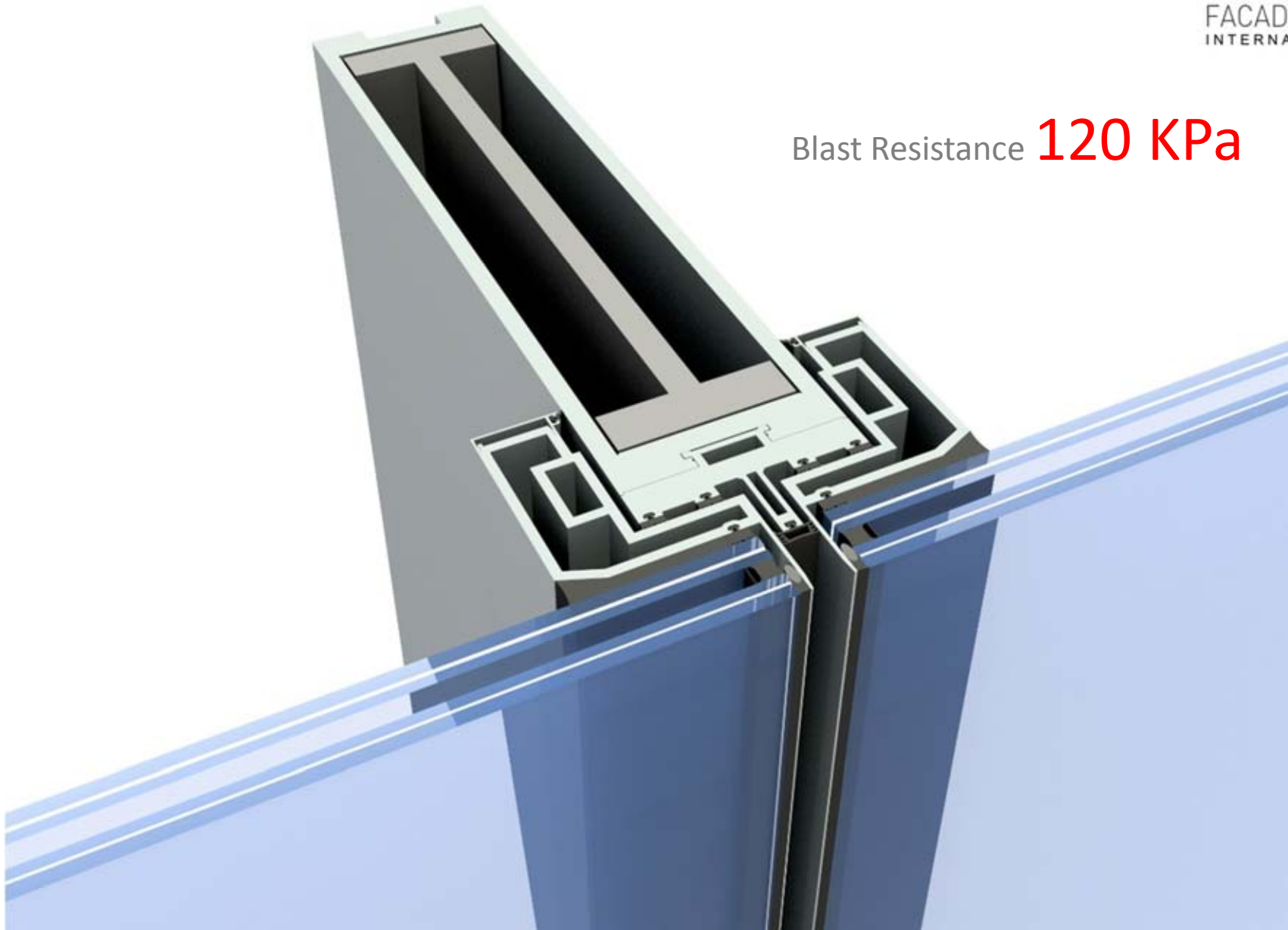

# CURTAIN WALLS

---

Innovation to Energy facades

**THERMAL BREAK** CAP CURTAIN WALL

MULLION DETAIL



FACADE **ONE**  
INTERNATIONAL

**SYSTEM**

U VALUE – 4 W/m<sup>2</sup>.K

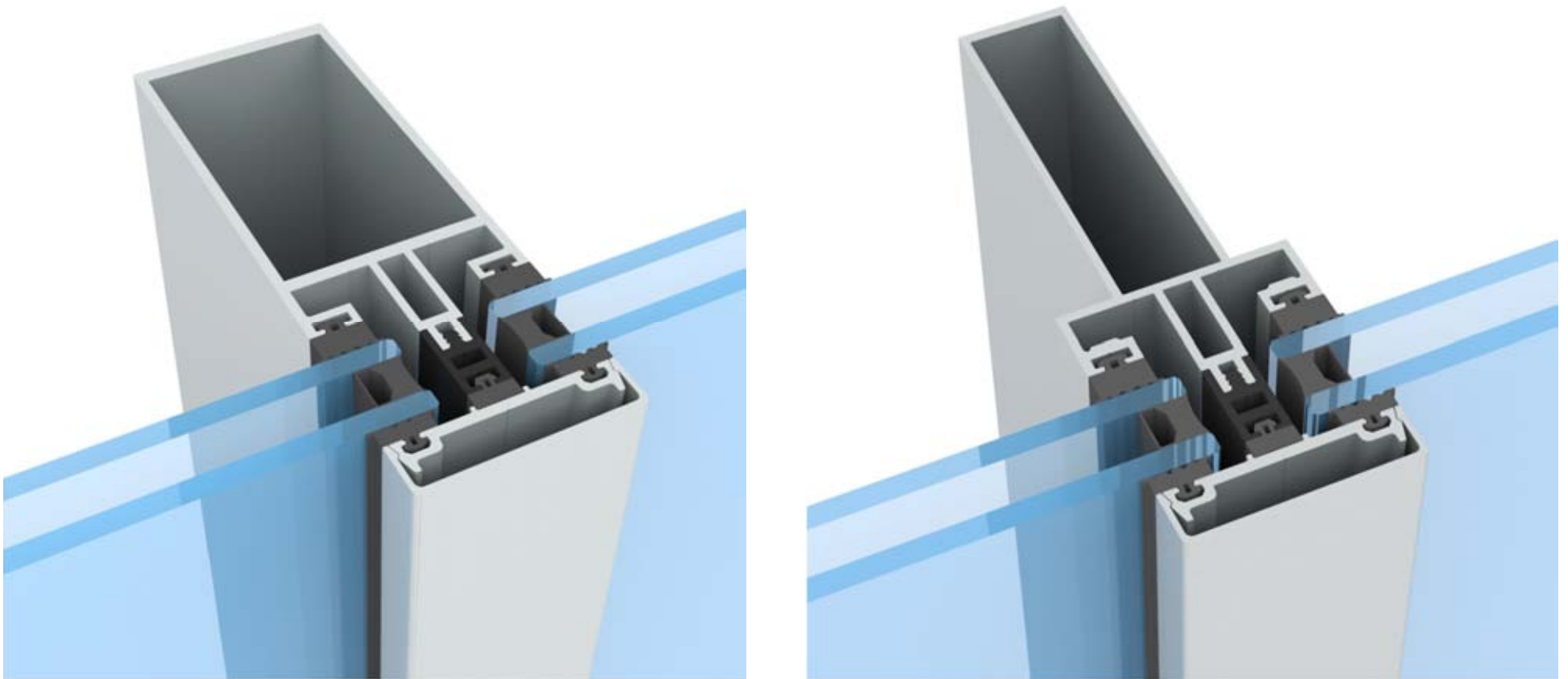



**STICK** CURTAIN WALL (TOGGLE SYSTEM)

MULLION DETAIL



**SYSTEM**

U VALUE – 4.5 W/m<sup>2</sup>.K

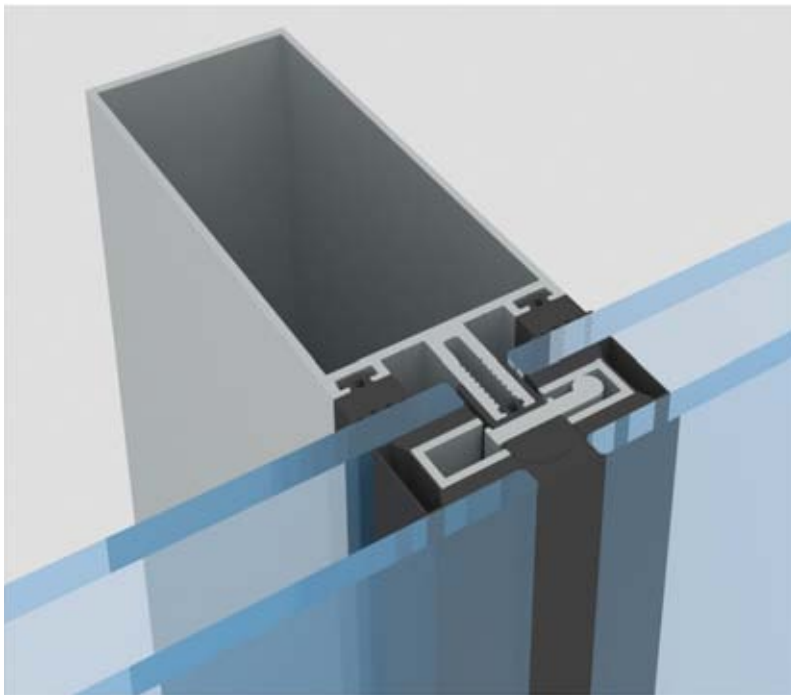

**SYSTEM**

U VALUE – 2.7 W/m<sup>2</sup>.K

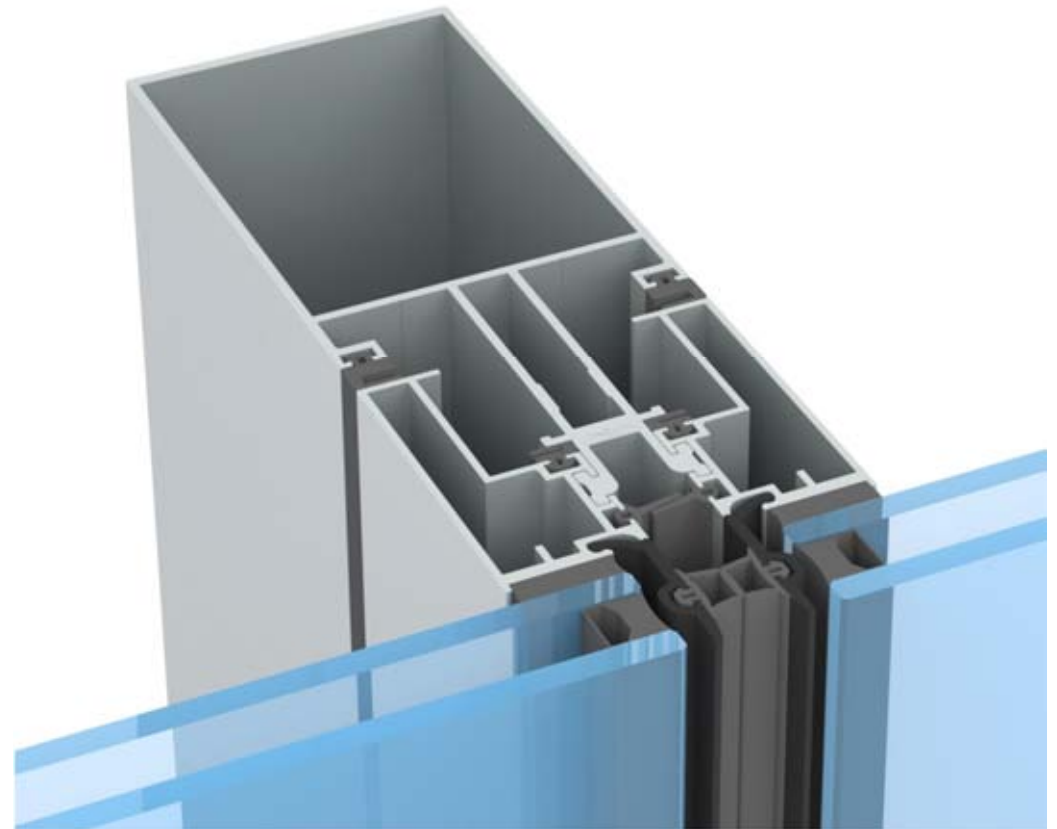

**ARTICULATED** CURTAIN WALL (THERMAL BREAK)

MULLION DETAIL



**SYSTEM**

U VALUE – 3.8 W/m<sup>2</sup>.K

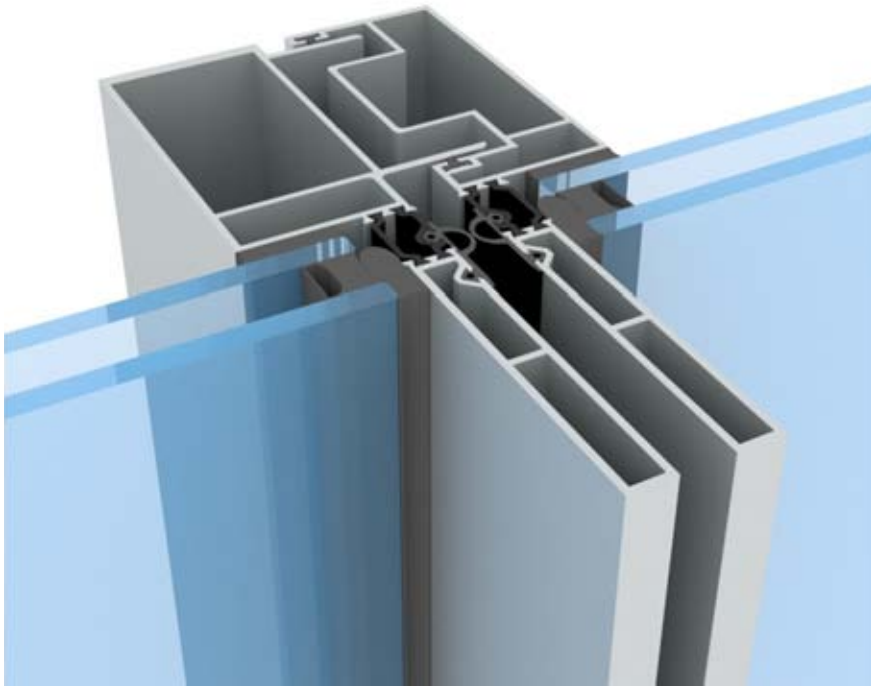

**SYSTEM**

U VALUE – 7.8 W/m<sup>2</sup>.K

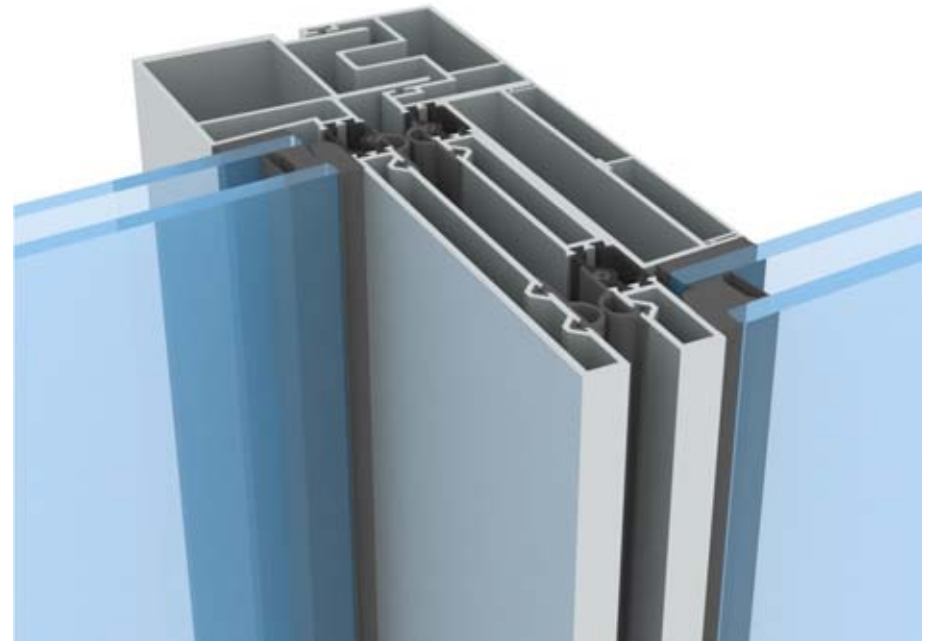

**EUROPEAN** CURTAIN WALL (POLYAMIDE / SILICON GASKET EDGE GUARD)

MULLION DETAIL



**SYSTEM**

U VALUE – 2.3 W/m<sup>2</sup>.K

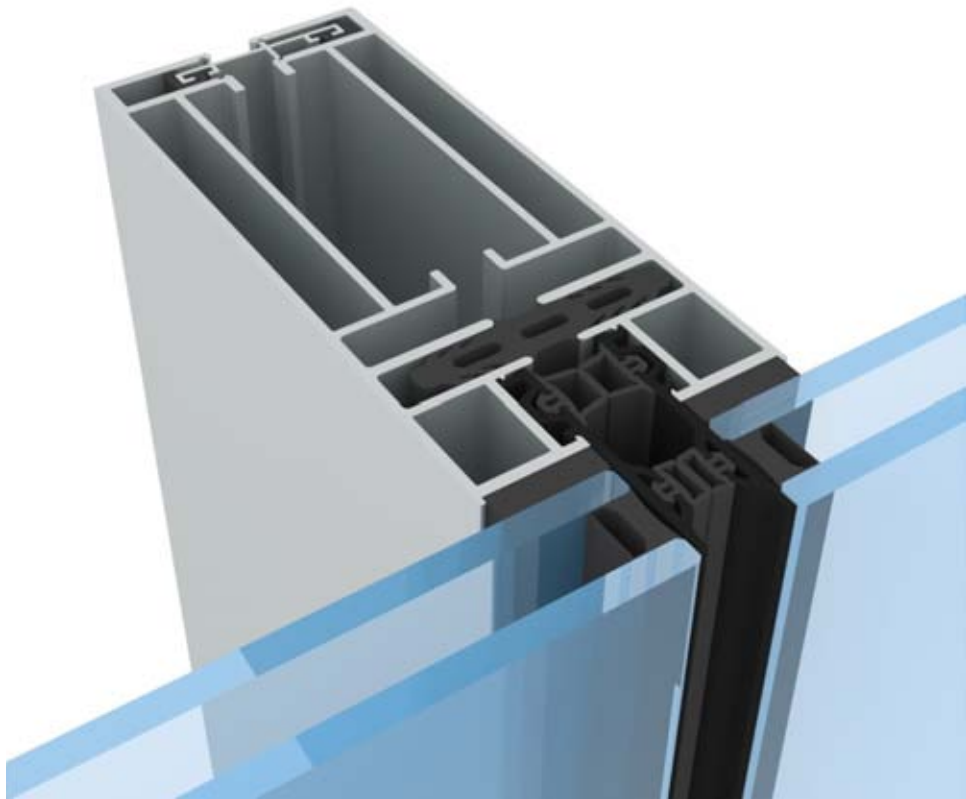

**SYSTEM**

U VALUE – 1.8 W/m<sup>2</sup>.K

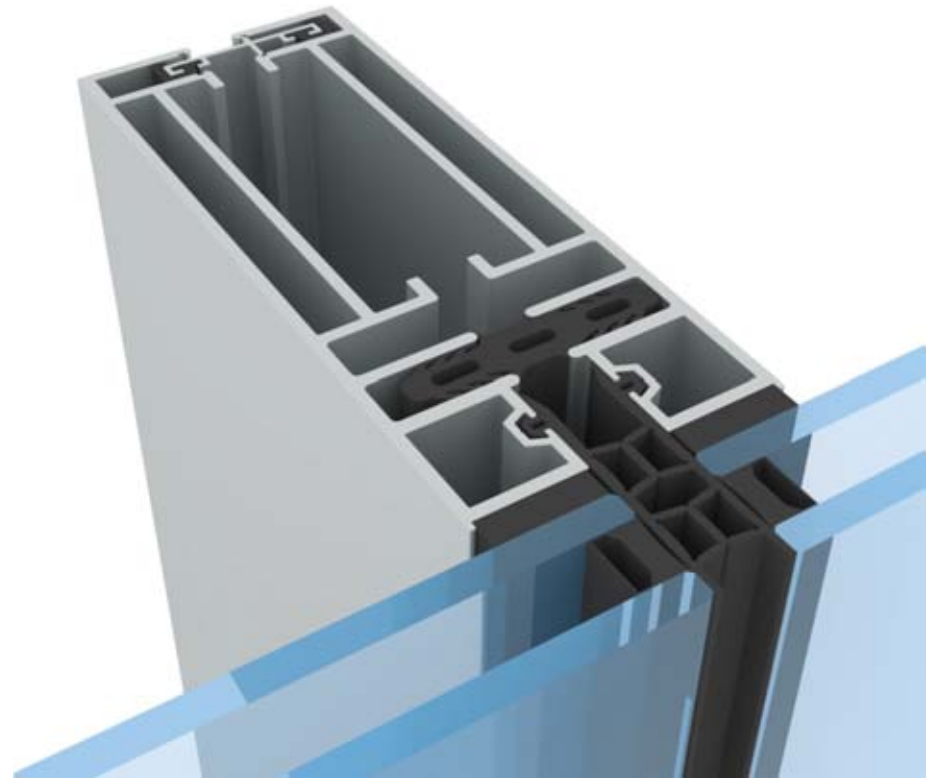

ENERGY FACADES – NON-THERMAL VS THERMAL BREAK CURTAIN WALL

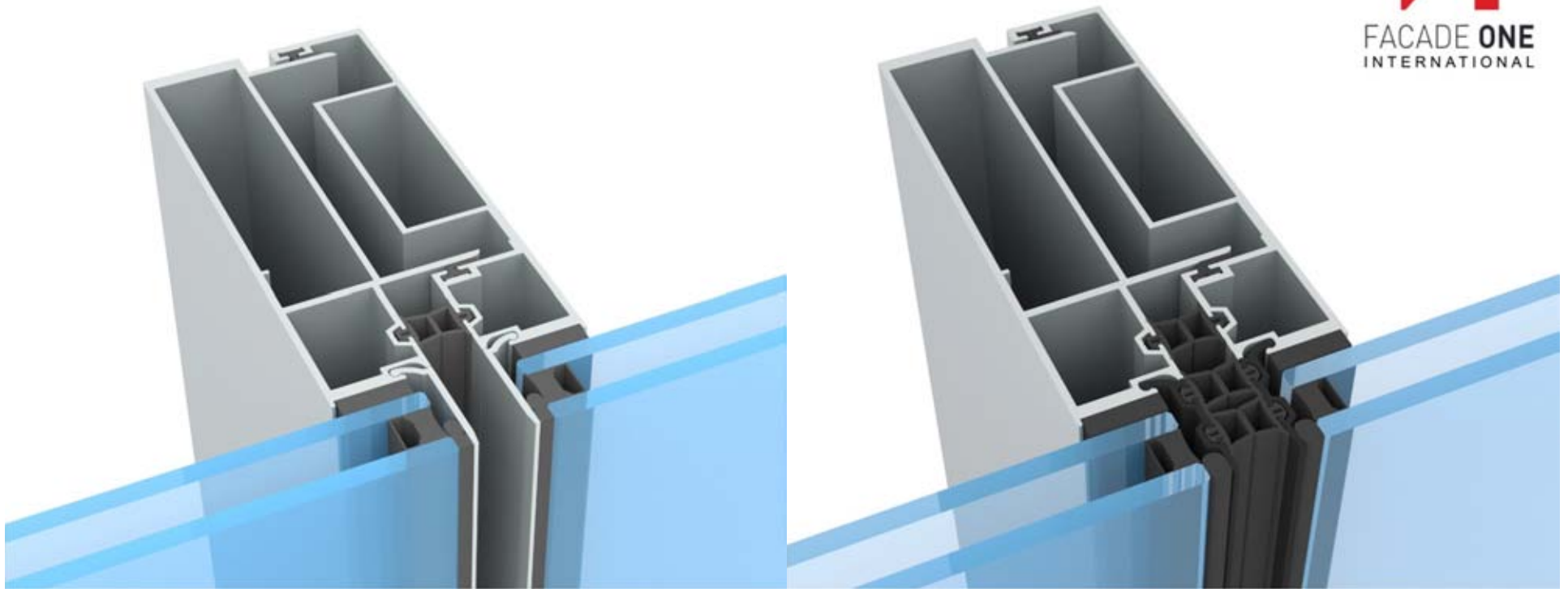

MULLION DETAIL

Profile U Value – 15.3 W/m<sup>2</sup>K  
Glass U Value - 1.7 W/m<sup>2</sup>K

OVERALL FAÇADE ASSEMBLY U  
VALUE – 2.5 W/m<sup>2</sup>K

By using Non thermal Break curtain wall system glass U value performance reduces by 50%.

Profile U Value – 2.7 W/m<sup>2</sup>K  
Glass U Value – 1.7 W/m<sup>2</sup>K

OVERALL FAÇADE ASSEMBLY U  
VALUE – 1.43 W/m<sup>2</sup>K

By using Thermal Break Curtain wall system , glass U value performance improves by 16% .

Thermal Break profile **improves over all façade U value by 75 %** against Non thermal break



ENERGY FACADES – NON-THERMAL VS THERMAL BREAK CURTAIN WALL

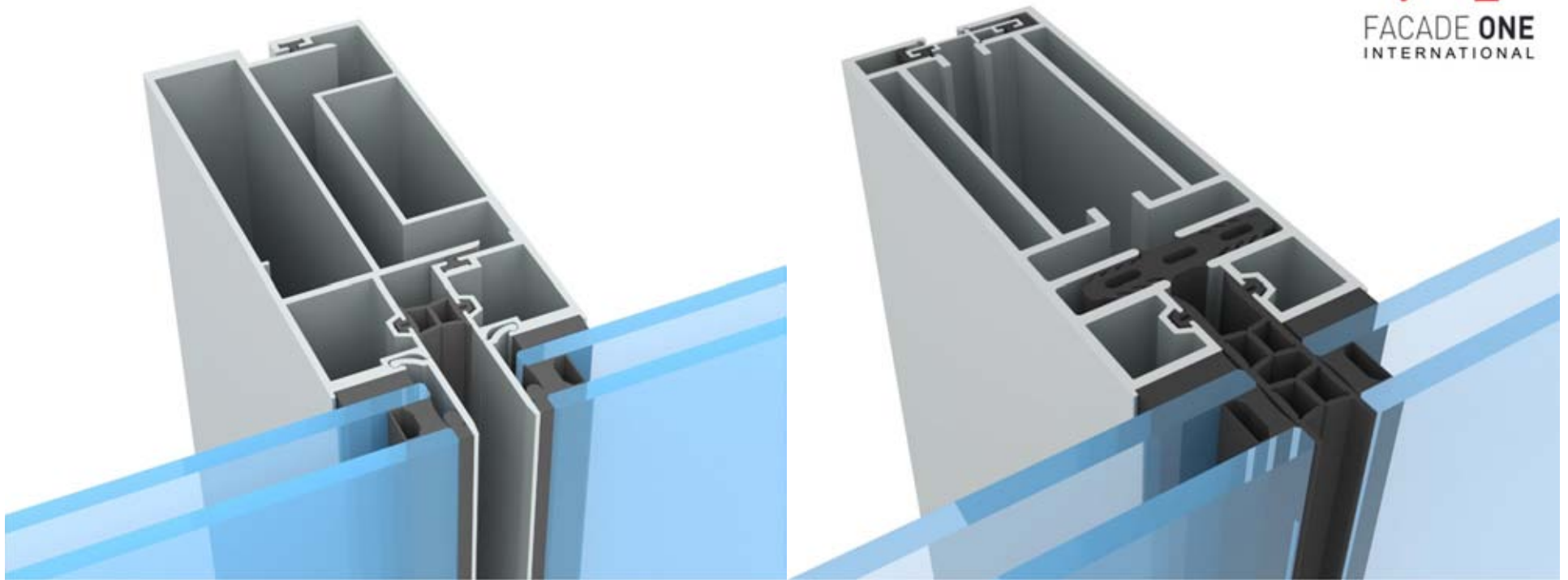

MULLION DETAIL

Profile U Value – 15.3 W/m<sup>2</sup>K  
Glass U Value - 1.7 W/m<sup>2</sup>K

OVERALL FAÇADE ASSEMBLY U  
VALUE – 2.5 W/m<sup>2</sup>K

By using Non thermal Break curtain wall system glass U value performance reduces by 50%.

Profile U Value – 1.8 W/m<sup>2</sup>K  
Glass U Value – 1.7 W/m<sup>2</sup>K

OVERALL FAÇADE ASSEMBLY U  
VALUE – 1.37 W/m<sup>2</sup>K

By using Thermal Break Curtain wall system , glass U value performance improves by 20% .

Thermal Break profile **improves over all façade U value by 83 %** against Non thermal break

## ENERGY WITH ACOUSTIC FACADES SUBFRAME

### MULLION DETAIL

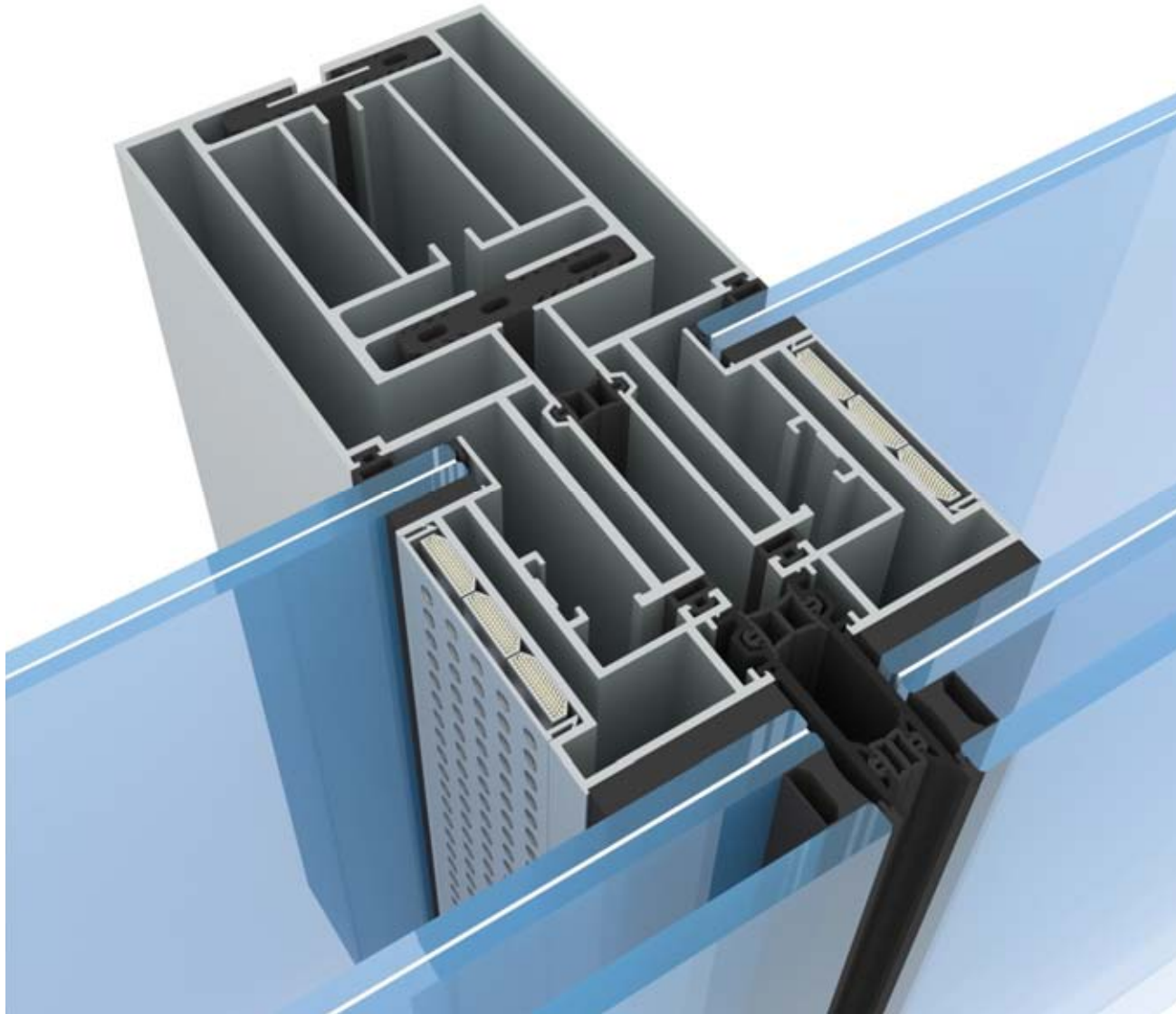

#### Profile Uf-Value

0.39 BTU/hr/ft<sup>2</sup>/°F (2.2 W/m<sup>2</sup>.K)

#### Vision Glass U Value (75%)

0.18 BTU/hr/ft<sup>2</sup>/°F (1.02 W/m<sup>2</sup>.K)

#### Spandrel Glass with Shadow bow ( 25%)

0.06 BTU/hr/ft<sup>2</sup>/°F (0.34 W/m<sup>2</sup>.K)

#### OVERALL FAÇADE ASSEMBLY U VALUE

0.17 BTU/hr/ft<sup>2</sup>/°F (0.94 W/m<sup>2</sup>.K)

Improved acoustic performance

Overall Façade Thermal Resistance Meeting **National Fenestration Rating Council (NFRC)** Energy Performance Requirement

DOUBLE SKIN WINDOW MULLION DETAILS

---



FACADE ONE  
INTERNATIONAL

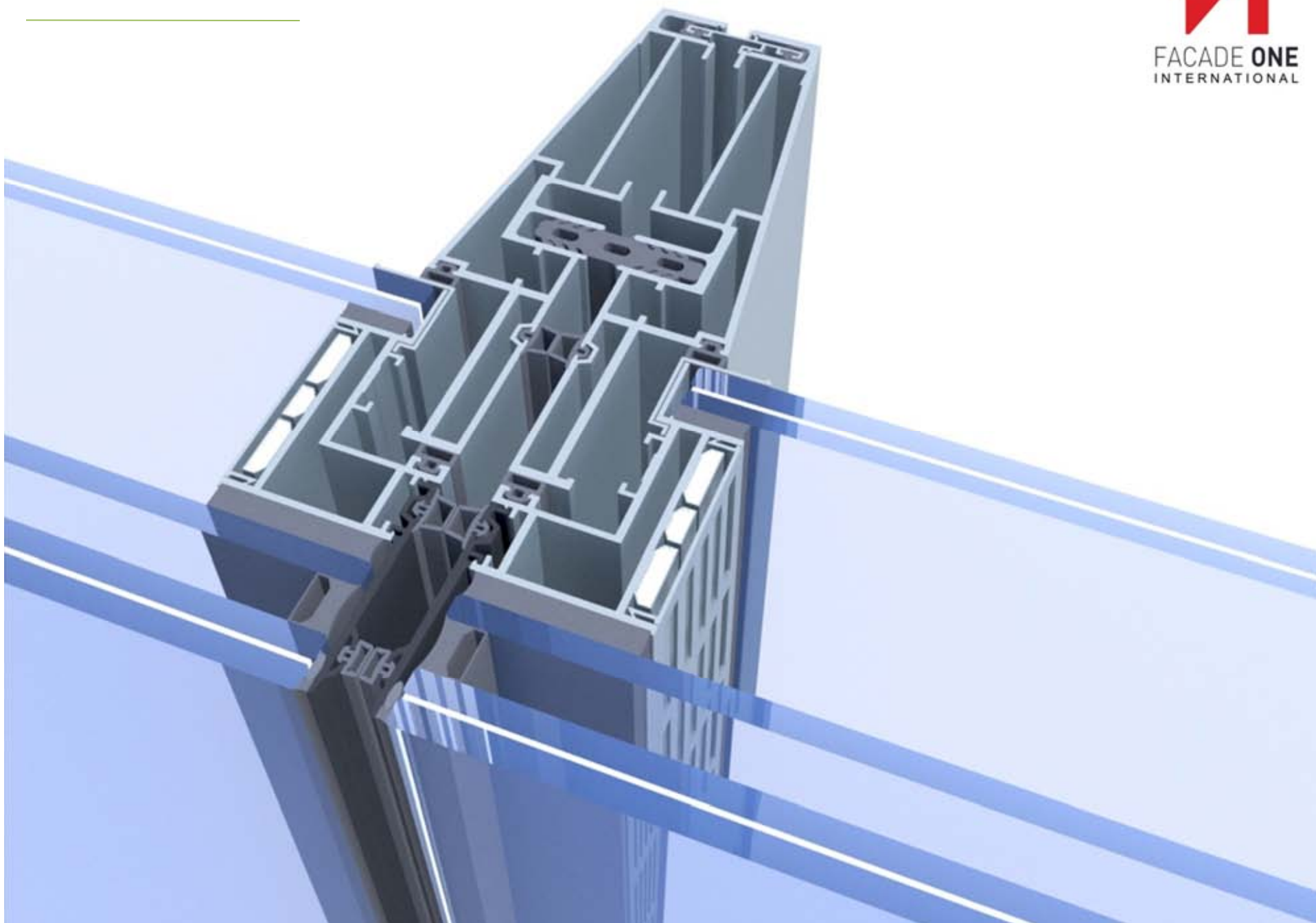

# UNIQUE FAÇADE CONCEPTS

---



## UNIQUE 3D FACADES

---



FACADE ONE  
INTERNATIONAL

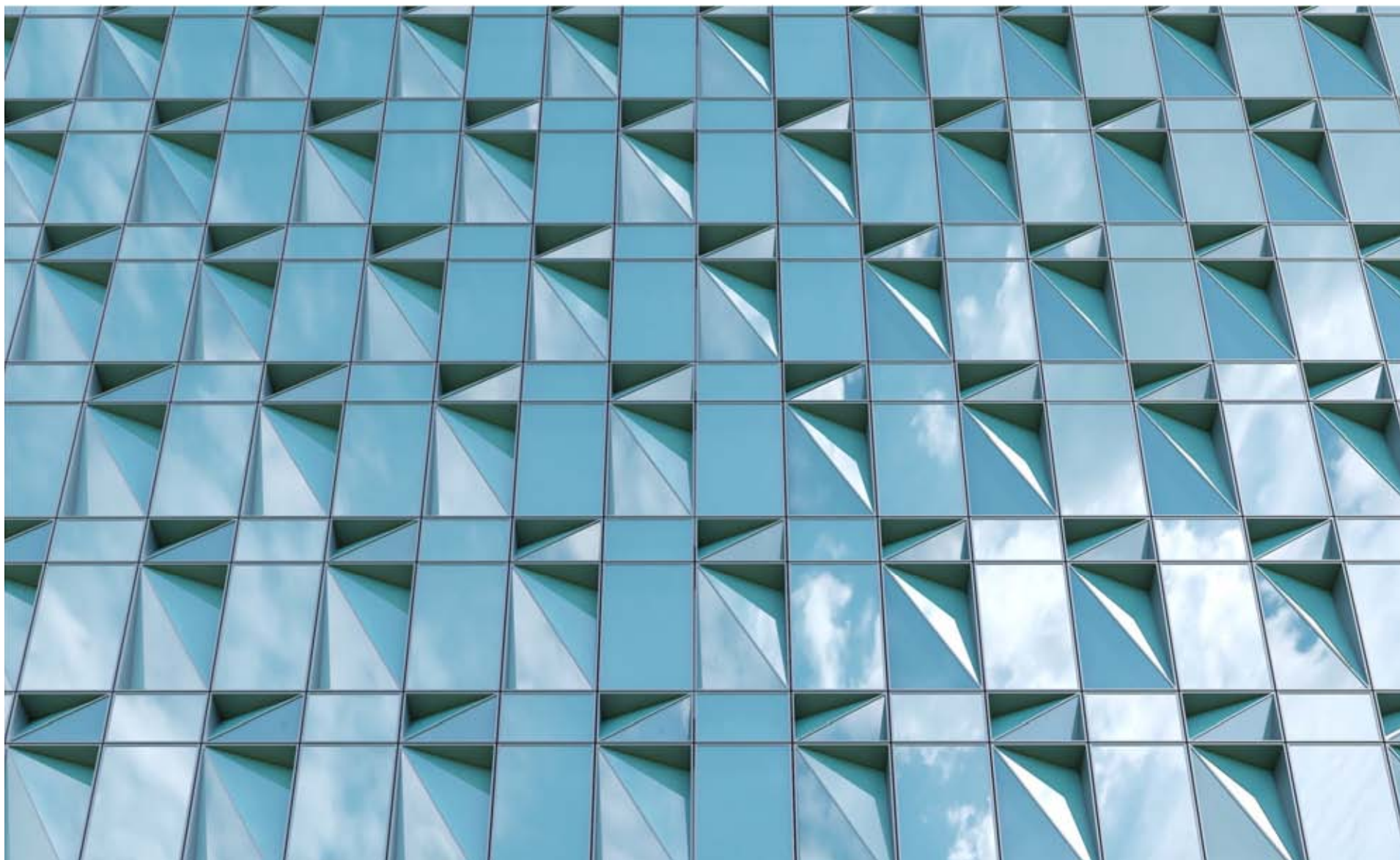

## 3D GLAZING

---



FACADE ONE  
INTERNATIONAL





## UNIQUE 3D FACADES

---



FACADE ONE  
INTERNATIONAL



## SKEWED AND ARTICULATED WALL



FACADE ONE  
INTERNATIONAL





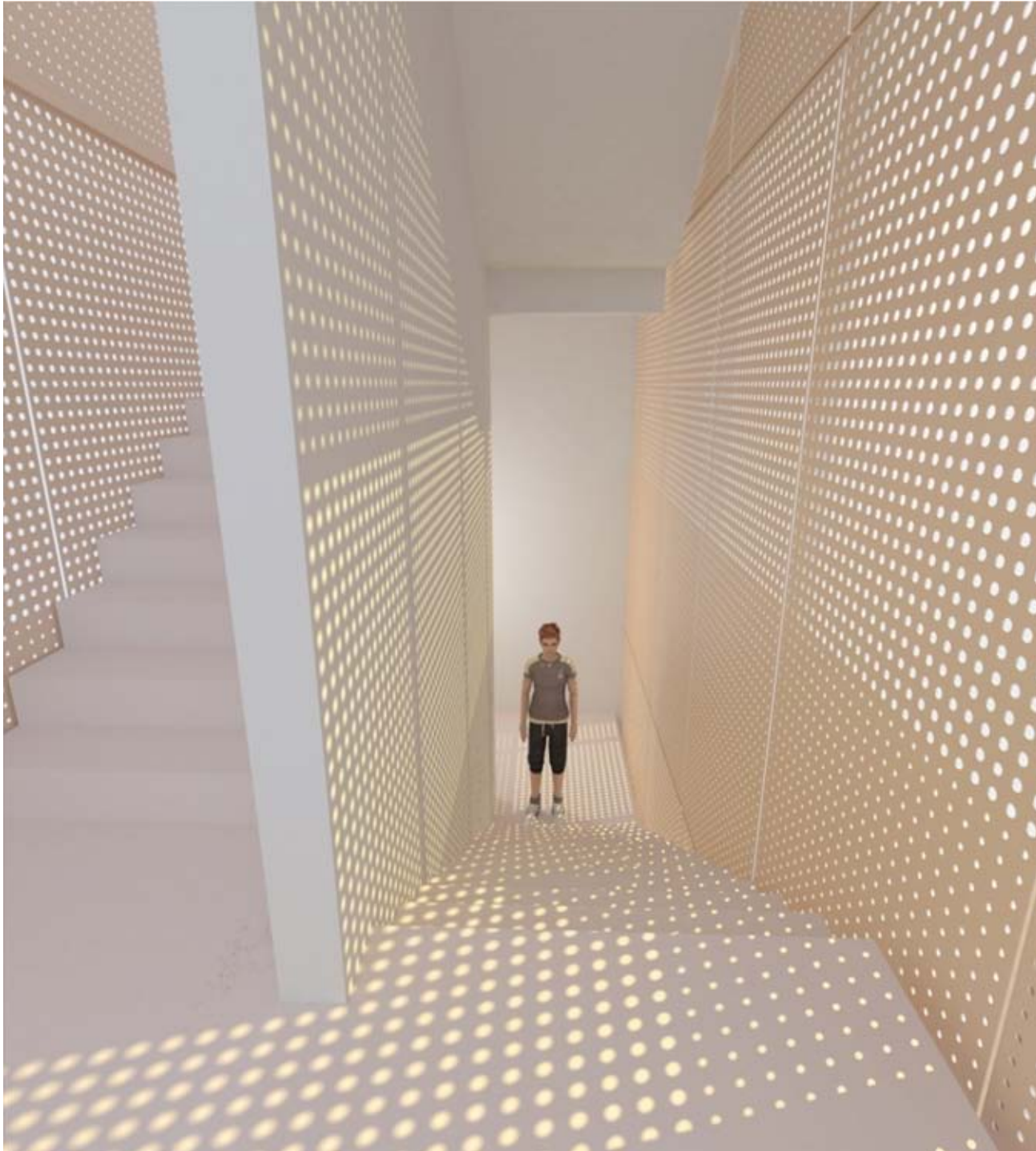

PERFORATED LIGHT WALL

# SKYLIGHT AND DOME

---

## GLASS DOME

---



FACADE ONE  
INTERNATIONAL

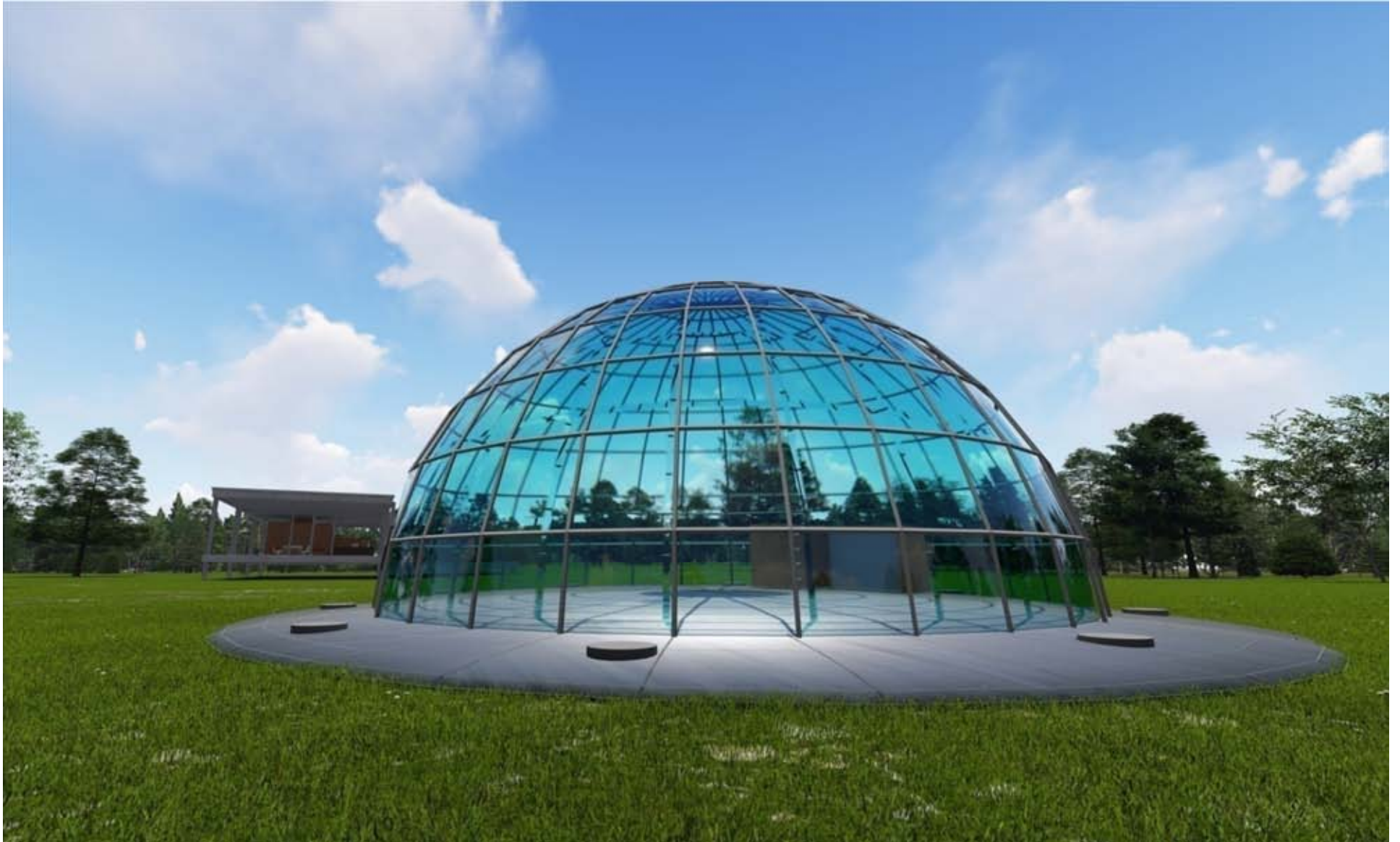



## REFLECTED VIEW SKYLIGHT

---



FACADE ONE  
INTERNATIONAL







# SWISSCLAD WALL CLADDING

---

Innovation to Life Safety

# SWISSCLAD

---

- Aluminium wall cladding system
- All aluminium solid profiles
- Non Combustible fire class A1. Life safe cladding
- Approved by IBC & NBC
- Various sizes and shapes



# LIMITATIONS IN CONVENTIONAL MATERIAL

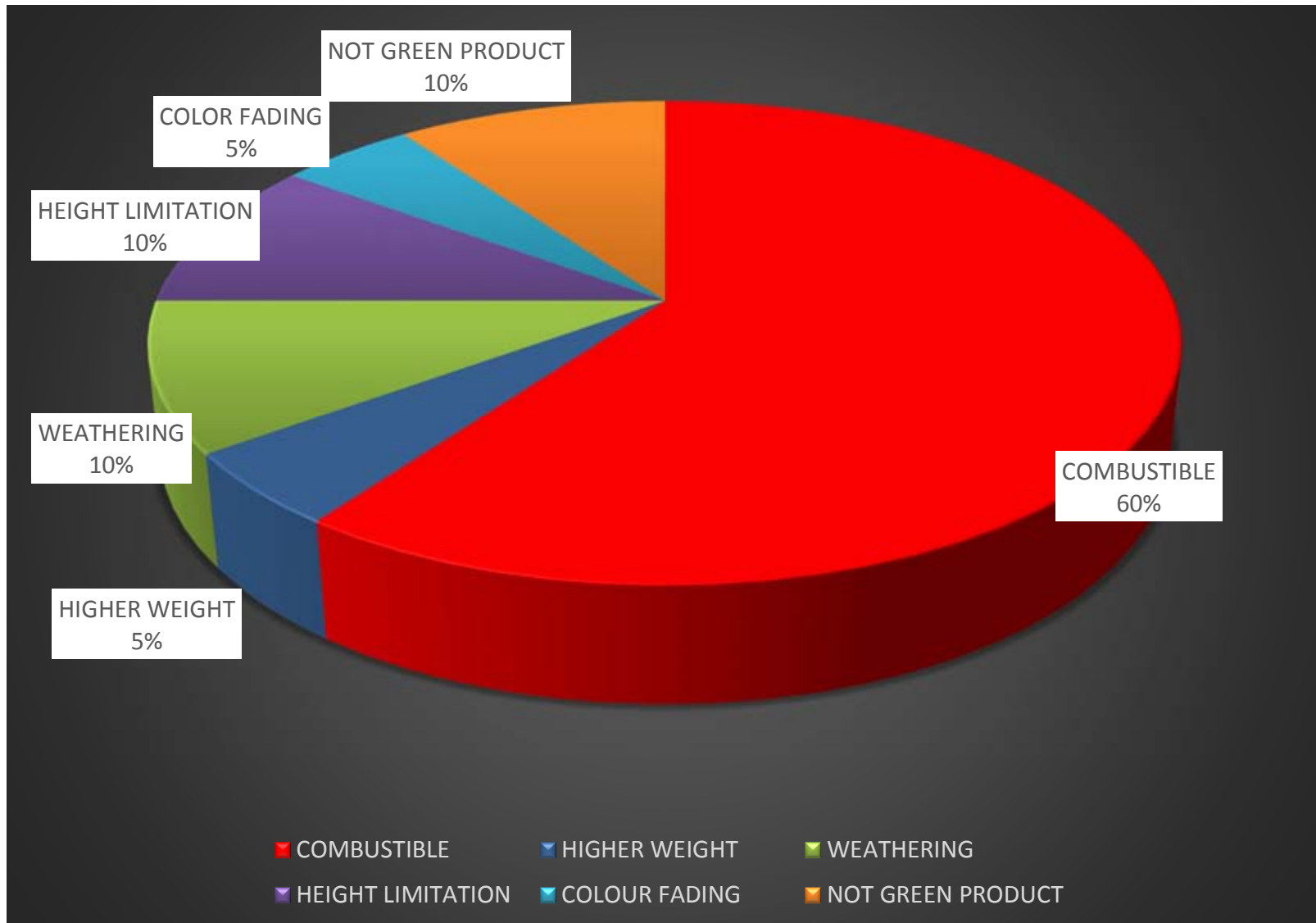

# TODAY'S CHALLENGES

---

## SPREAD OF FIRE THROUGH EXTERIOR FAÇADE



# DOHA, QATAR - 2006



Fire spread through ACP Cladding

# ASTANA, KAZAKHSTAN - 2006



Fire spread through ACP Cladding

# GREENFELL TOWER - LONDON

---



Fire spread through ACP Cladding



# SWISSCLAD

---



## FIRE PROOF – NO SMOKE



## ZERO COMBUSTIBILITY

**SWISSCLAD**  
SPANDREL PANEL





SCLAD 150 SPANDREL



DETAIL VIEW

**SWISSCLAD**  
COPPER FINISH



SCLAD 150



FACADE ONE  
INTERNATIONAL

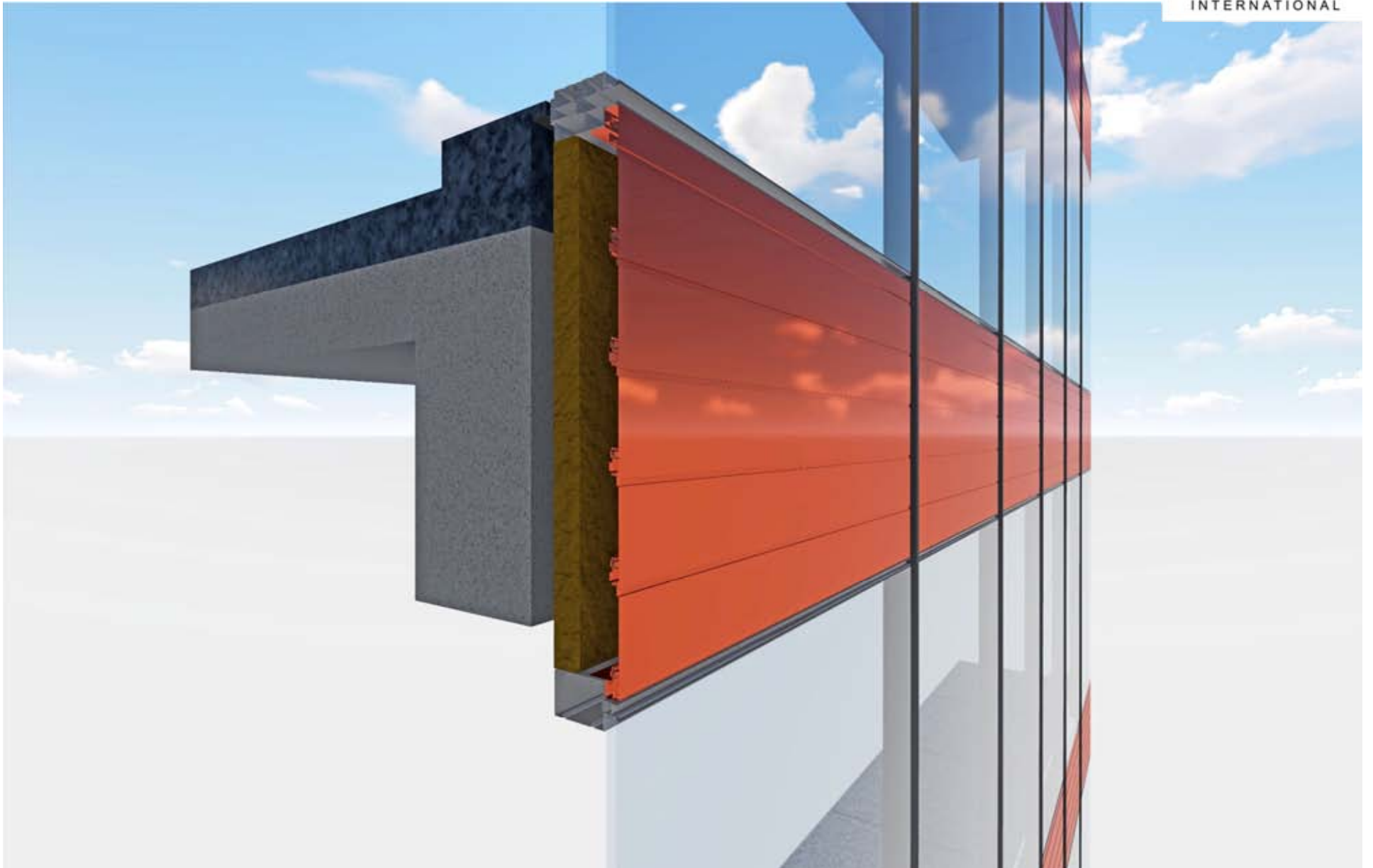



**SWISSCLAD**

SKEWED GLAZING SPANDREL



**FACADE ONE**  
INTERNATIONAL



# SWISSCLAD

ARTICULATED WALL SPANDREL



FACADE **ONE**  
INTERNATIONAL





SWISS CLAD SUPREME



FACADE ONE  
INTERNATIONAL





SWISS CLAD SUPREME



FACADE ONE  
INTERNATIONAL



CONCEALED WINDOW CONCEALED JAMB DETAILS

---



FACADE ONE  
INTERNATIONAL





FERRING PHARMA WITH SWISS CLAD



FACADE ONE  
INTERNATIONAL





## UNIQUE FACADE

---



FACADE ONE  
INTERNATIONAL



CONCEALED WINDOW CONCEALED JAMB DETAILS

---



FACADE ONE  
INTERNATIONAL





**CONCEALED** WINDOW CONCEALED JAMB DETAILS

---



**FACADE ONE**  
INTERNATIONAL



SWISSCLAD



FACADE ONE  
INTERNATIONAL





**SCLAD**  
FALSE CIELING



SCLAD  
SOFFIT



FACADE ONE  
INTERNATIONAL





**SWISSCLAD**

INTERIOR APPLICATION



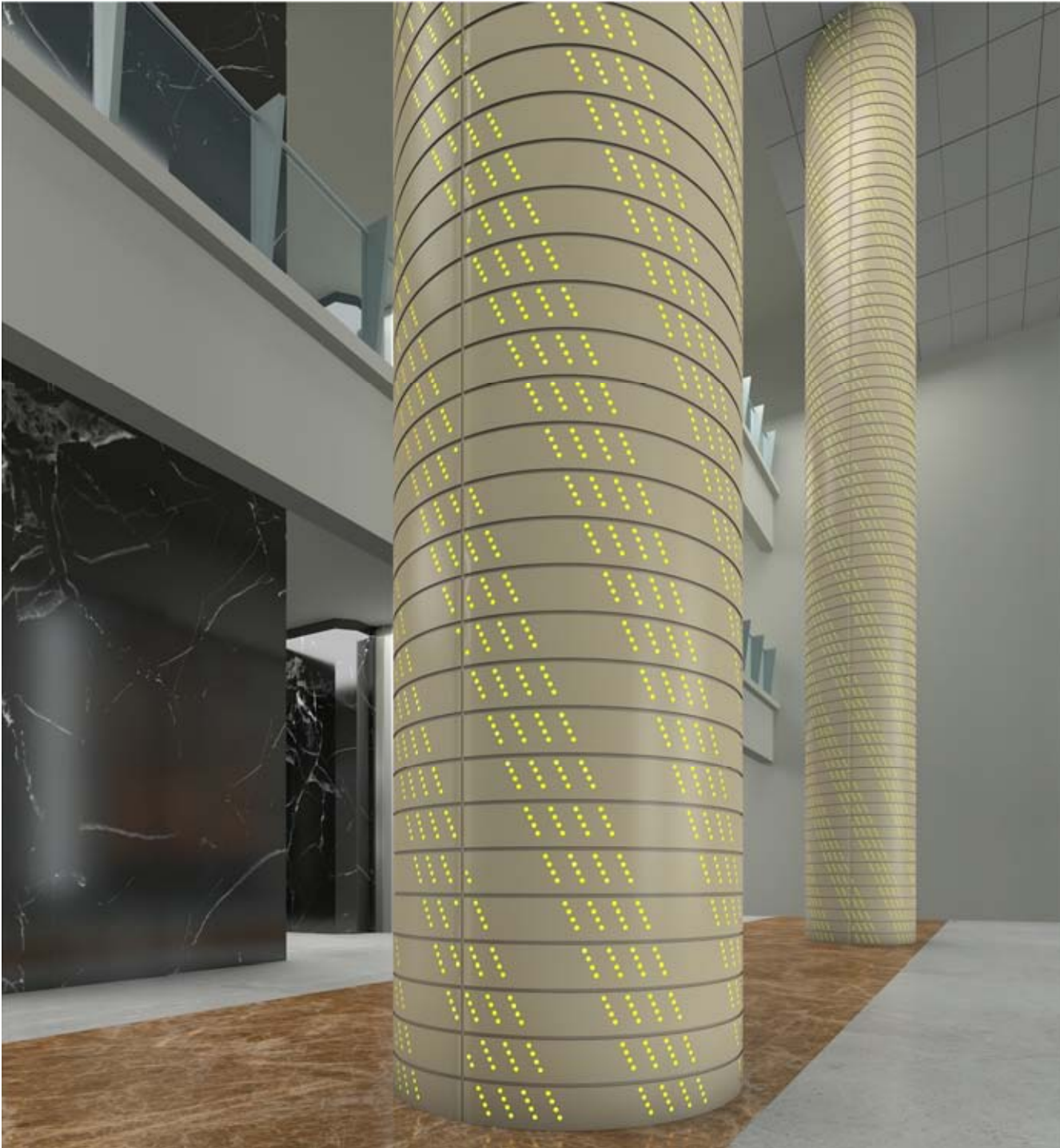

**SWISSCLAD**  
PERFORATED COLUMN



**SCLAD**  
FALSE CIELING



# SWISSCLAD

## VARIANTS



FACADE ONE  
INTERNATIONAL



SCLAD 150



OFFSET 150



ZIGMA 150

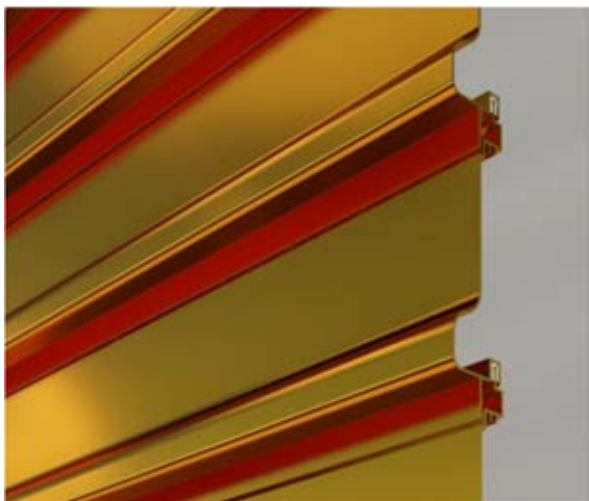

OMEGA 150



OMEGA 250

ALSO CUSTOMIZED  
AS PER YOUR REQUIREMENT

# SWISSCLAD

## VARIANTS



FACADE ONE  
INTERNATIONAL



SIGMA 200



APEX 100

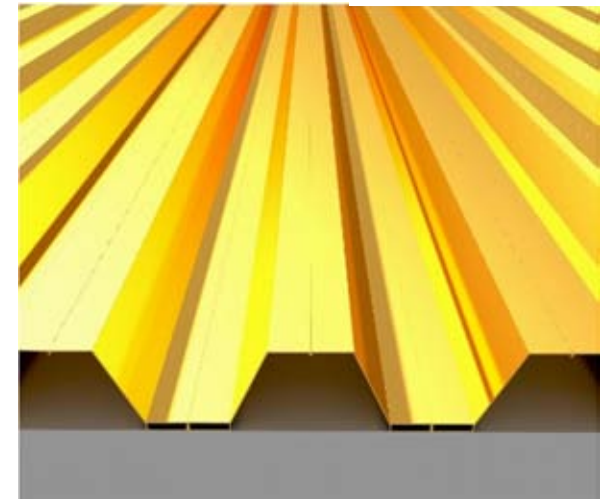

OFFSET 220

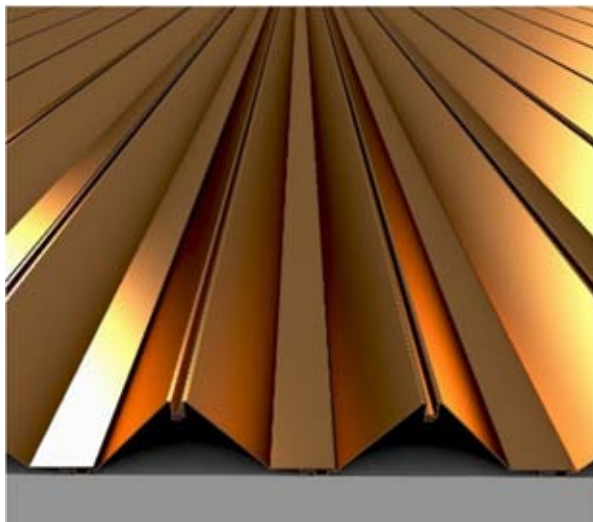

APEX 260

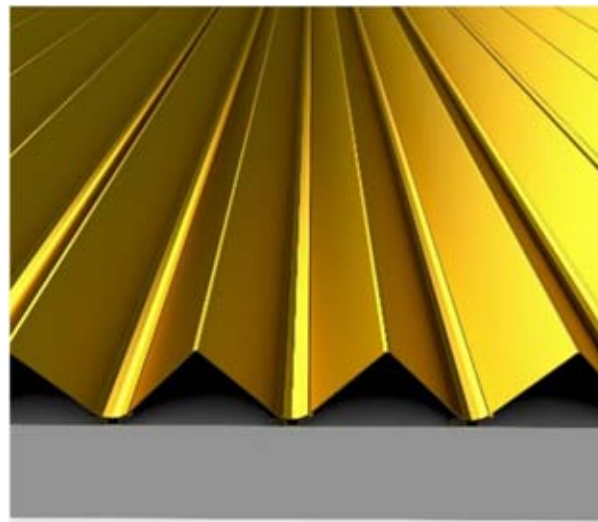

APEX 230

ALSO CUSTOMIZED  
AS PER YOUR REQUIREMENT





# SWISS CLADDING

---

## CONNECTION DETAILS

## SWISS CLADDING

GRID SYSTEM



FACADE ONE  
INTERNATIONAL



## SWISS CLADDING

HOOK ON SYSTEM



FACADE **ONE**  
INTERNATIONAL

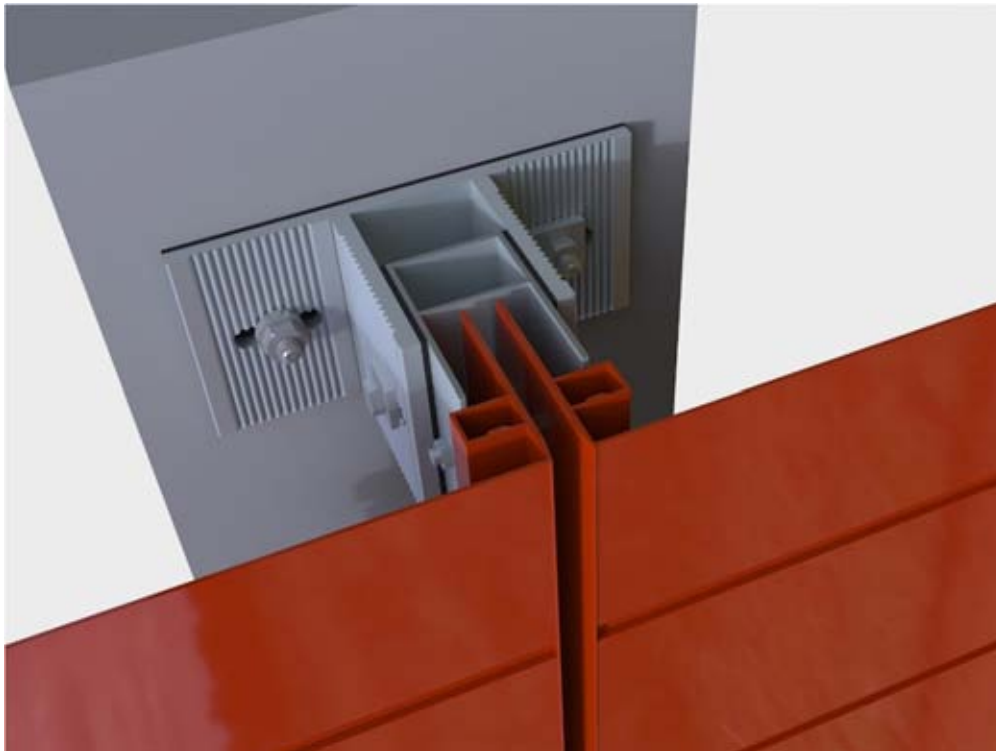



## SWISS CLADDING

UNITISED SYSTEM



FACADE **ONE**  
INTERNATIONAL

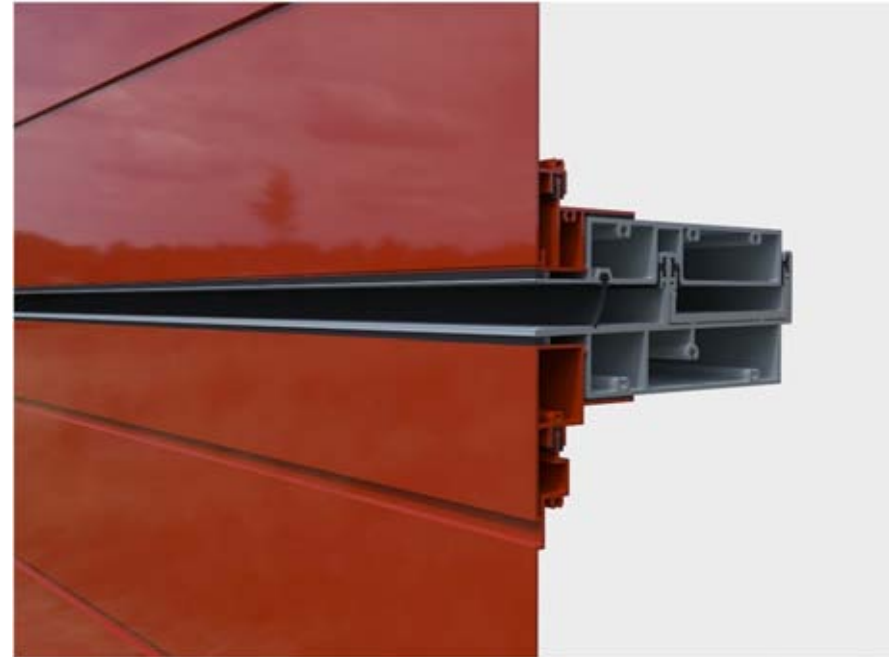
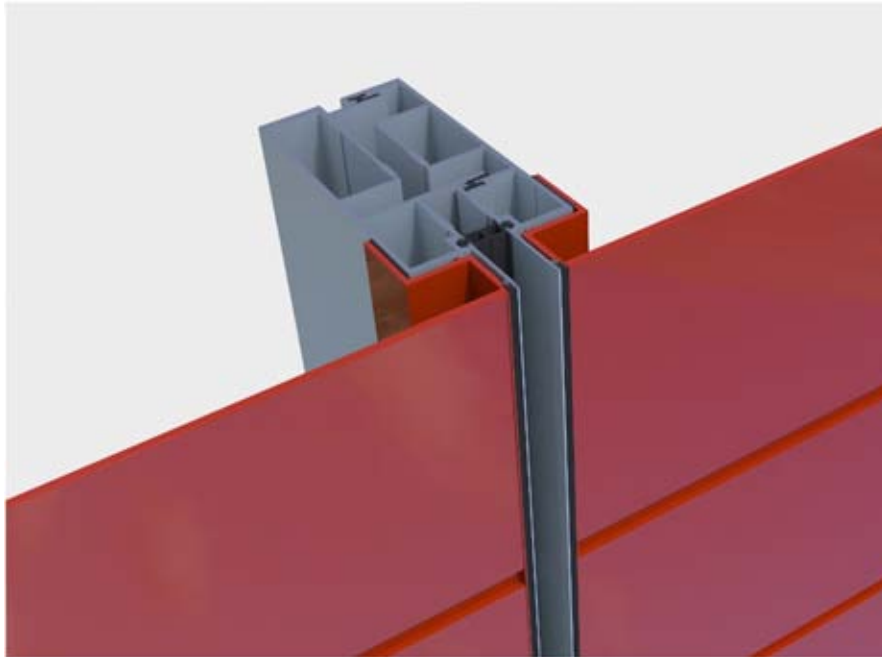

# SWISSCLAD

## 2D SECTIONS



FACADE ONE  
INTERNATIONAL

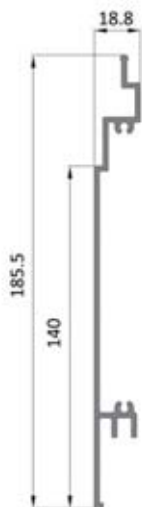

SCLAD 150

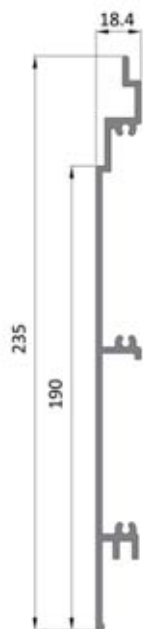

SCLAD 200

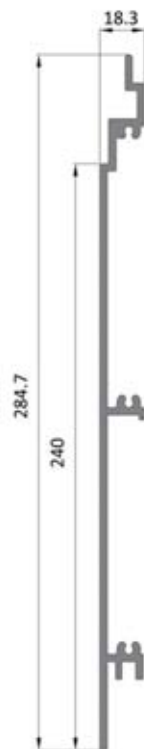

SCLAD 250

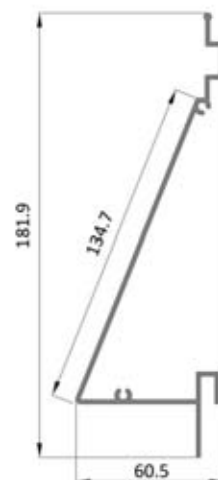

ZIGMA 150

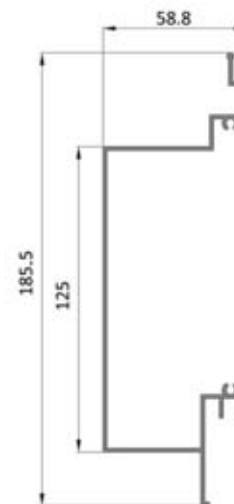

OFFSET 150

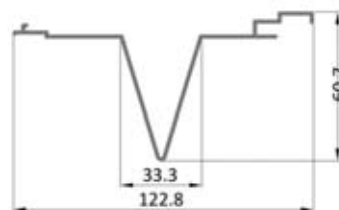

APEX 100

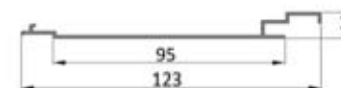

SCLAD 100

# TEST CERTIFICATIONS

---



Tested at **CBRI ROORKE**  
Fire Class **A1**  
Non Combustible  
No Toxic Smoke



Tested at **FAÇADE INDIA TESTING INC**  
Tested for WIND LOAD **1 KPa - 7 KPa**

# ROI

---

- Highest Return on Investment.
- Human Life , Intellectual data , Property safety under fire
- Lesser Insurance Premium from insurance co.
- Confirms to National / International Building code (NBC & IBC )
- Confirms to Local Fire Authority requirement ( CFO & Municipal )
- Confirms to Green Building Certification.



# DYNAMIC FACADES

---

## DYNAMIC FACADES

---



FACADE ONE  
INTERNATIONAL



# DYNAMIC FACADES

---



FACADE ONE  
INTERNATIONAL

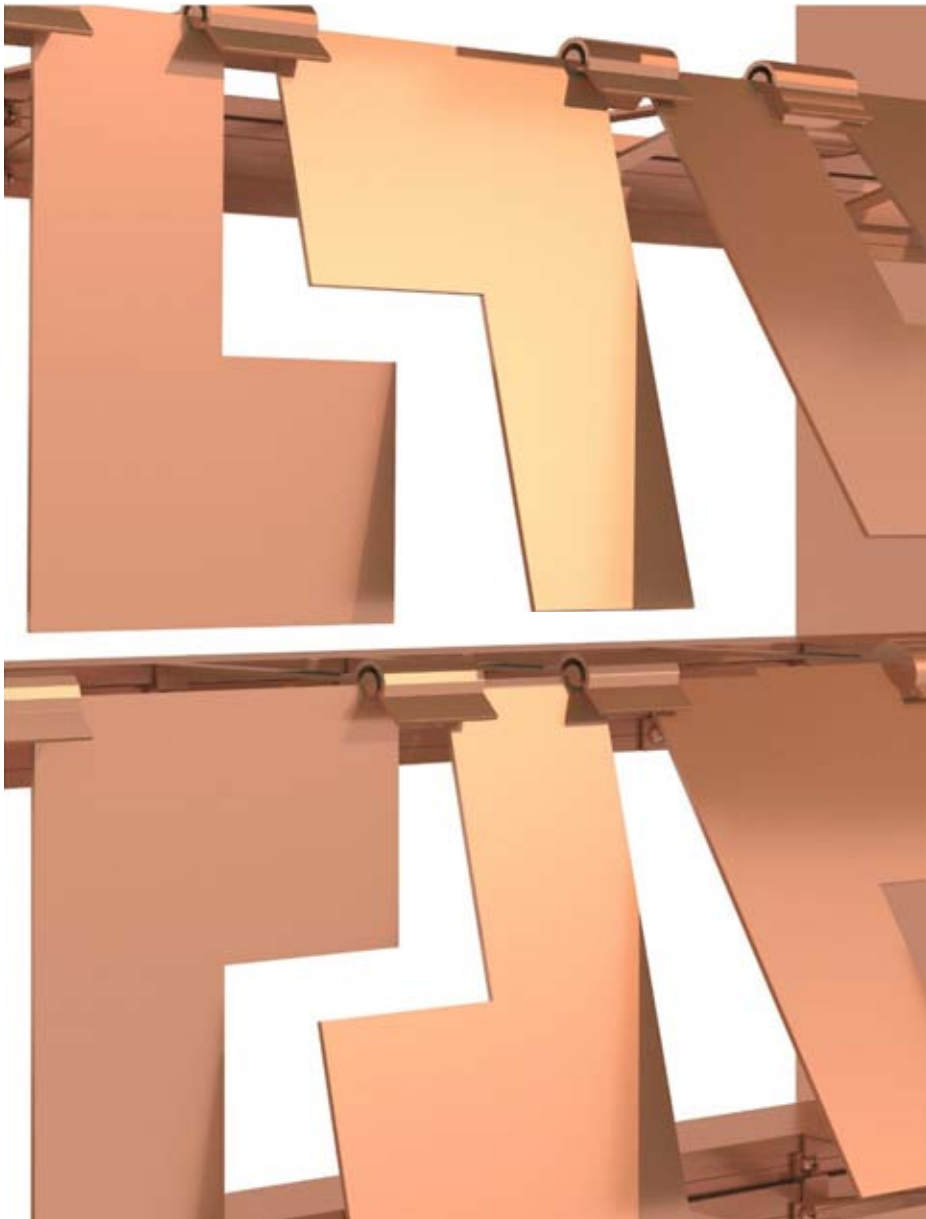

# DYNAMIC FACADES

---



FACADE ONE  
INTERNATIONAL

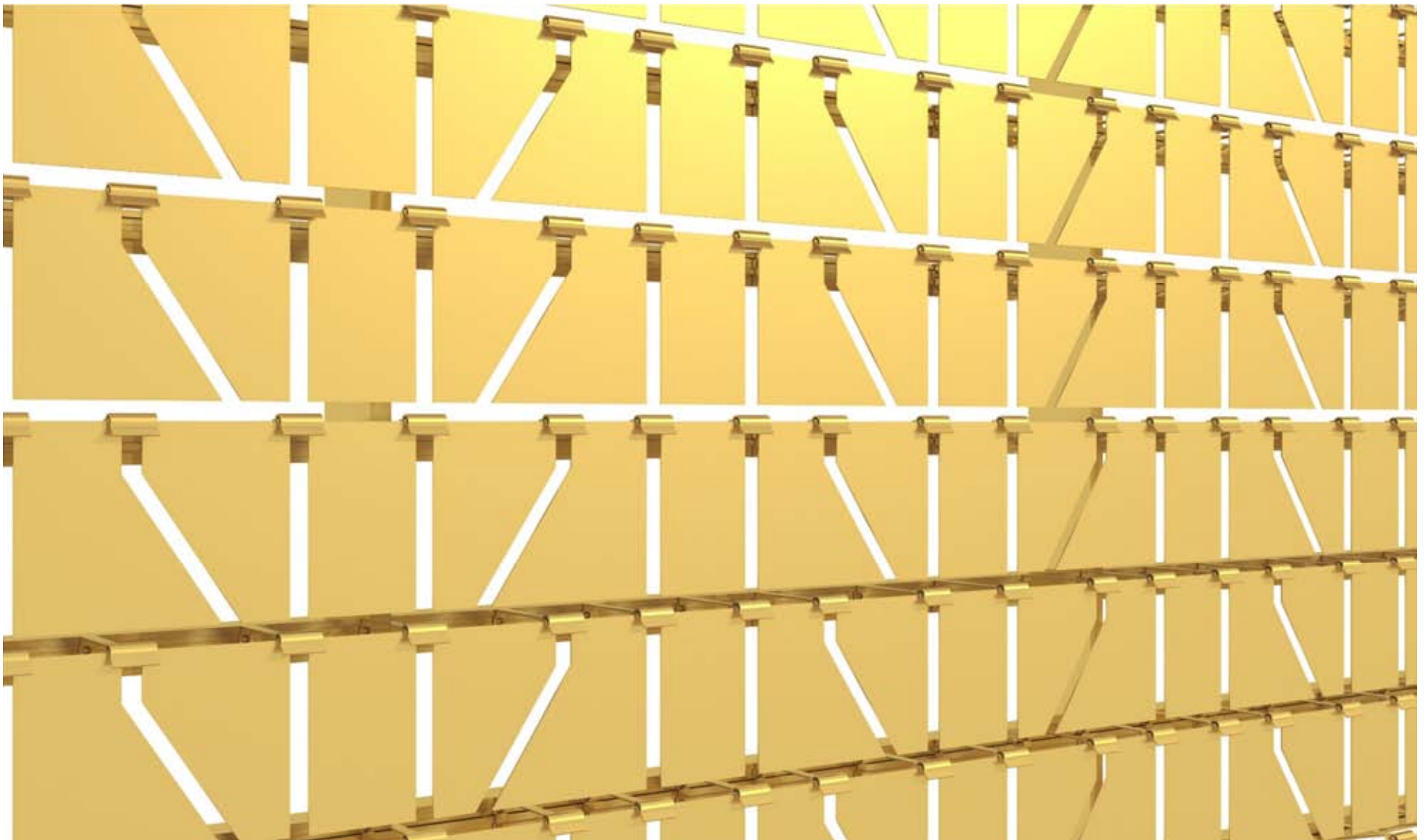



# DYNAMIC FACADES

---



FACADE ONE  
INTERNATIONAL

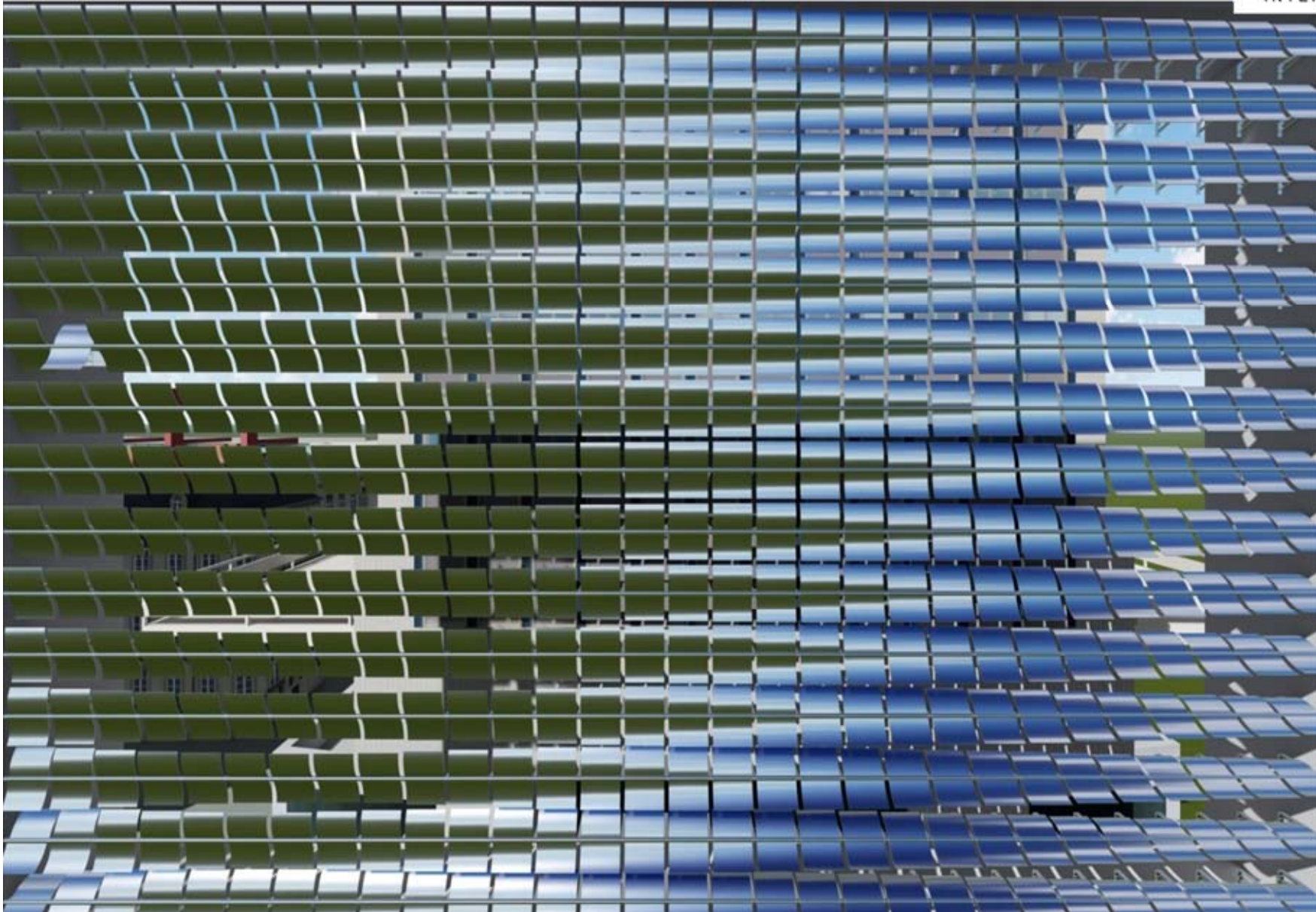



# DYNAMIC FACADES

---



FACADE ONE  
INTERNATIONAL

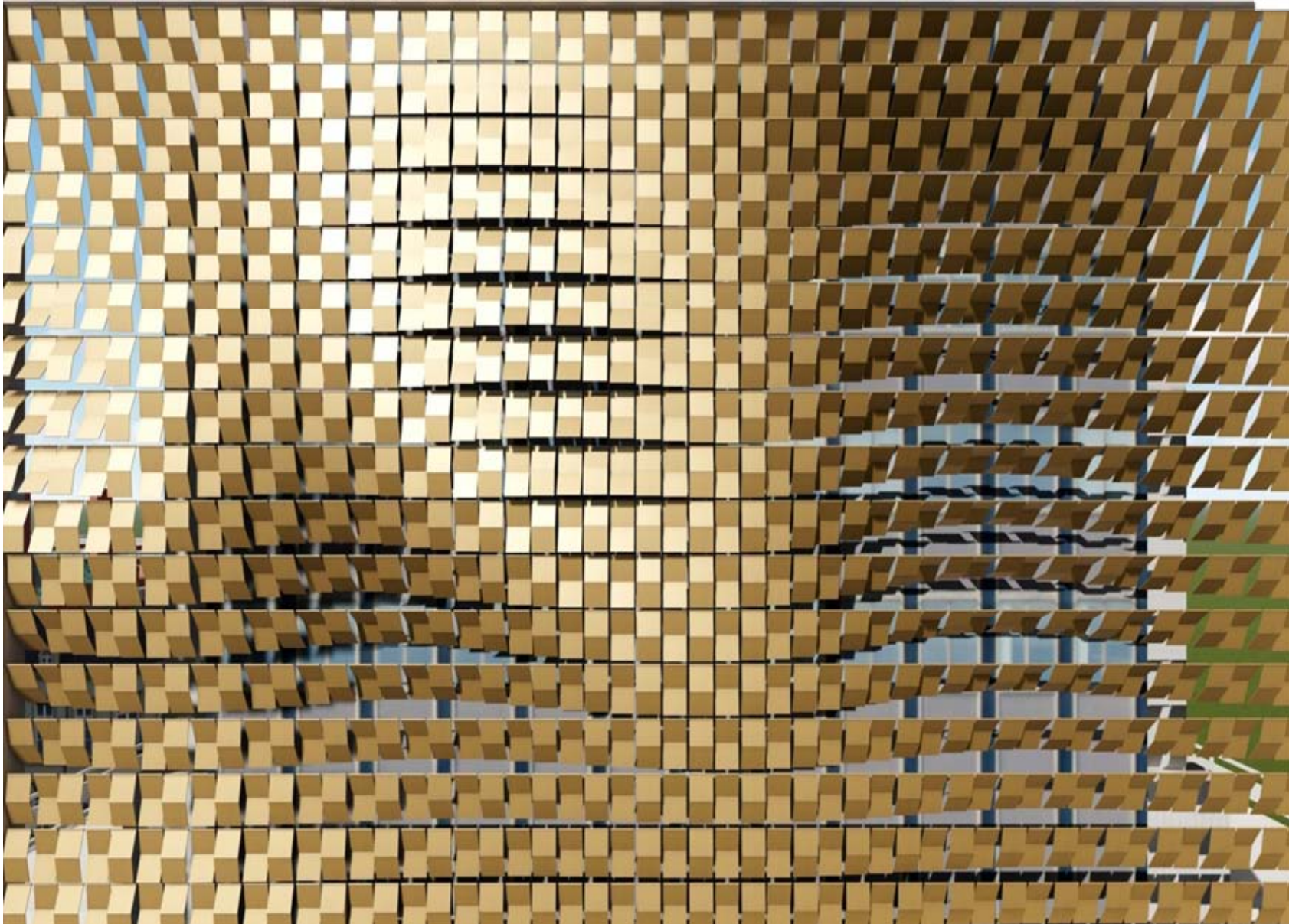

INNOVATION DETAIL - 1



# SLIM LINE SLIDING WINDOWS

---

Innovation to slim aesthetics



# SLIM LINE WINDOWS

- Slim Interlock – 20mm /26mm/30mm
- Height of Window – 2m – 6 m
- Air Tightness upto 500 Pa
- Water Tightness Upto 600 Pa
- Structural up to 9.5 kpa
- Complete range of windows
- European Accessories

## SLIDING WINDOW – 3T3S

---



FACADE **ONE**  
INTERNATIONAL



SLIDING WINDOW WITH INBUILT RAILING – 3T3S



FACADE **ONE**  
INTERNATIONAL



SLIDING WINDOWS WITH INBUILT RAILING – X-2X-X



FACADE ONE  
INTERNATIONAL





CORNER WINDOW



## CURTAIN WALL WITH STRUCTURALLY GLAZED WINDOW



FACADE ONE  
INTERNATIONAL



## CURTAIN WALL WITH **POPUP WINDOW**

---



FACADE **ONE**  
INTERNATIONAL





THERMAL BREAK 2T2S INSIDE FLUSHED TRACK



FACADE ONE  
INTERNATIONAL

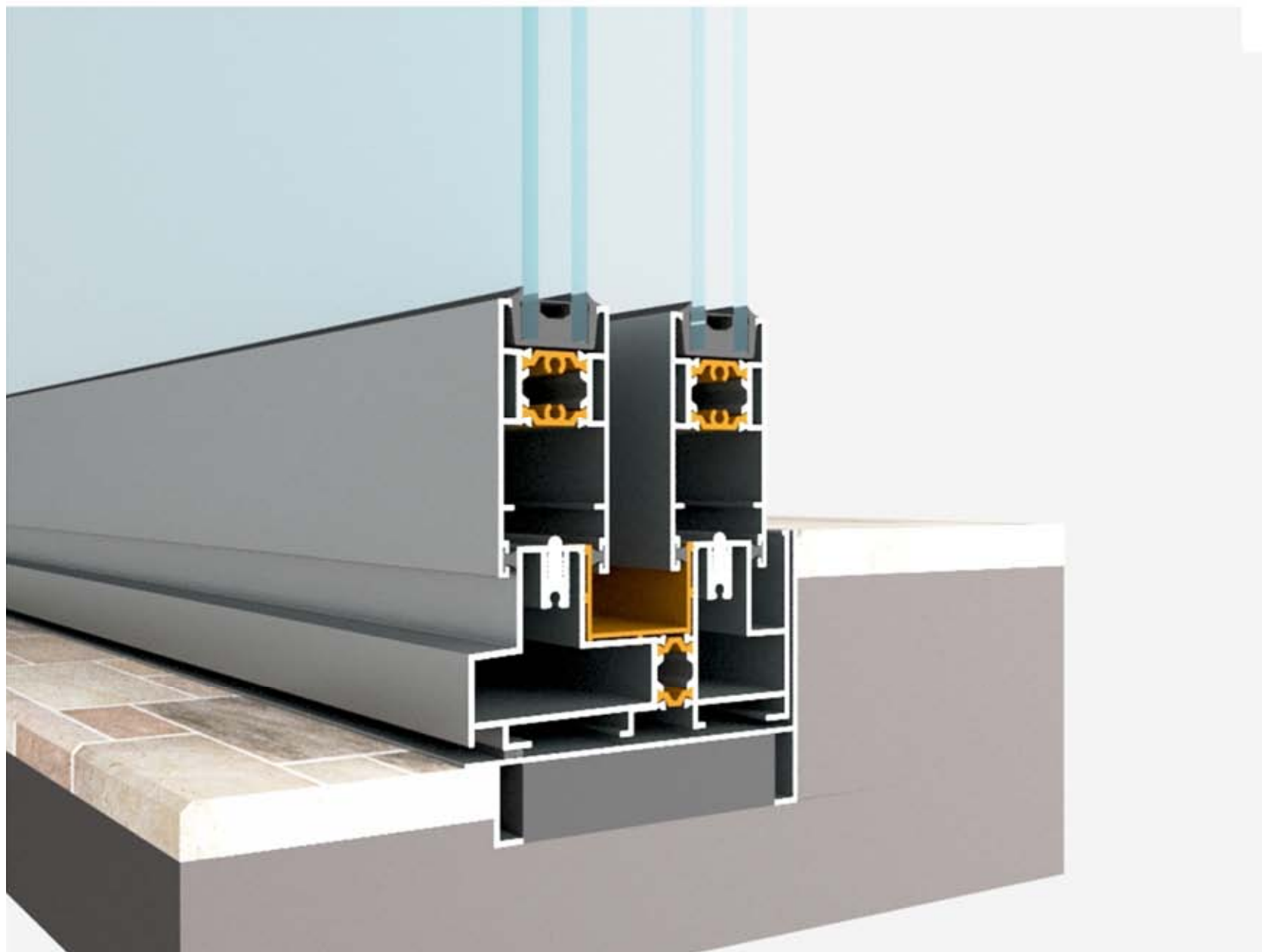



## THERMAL BREAK 2T2S FULL FLUSHED TRACK



FACADE ONE  
INTERNATIONAL

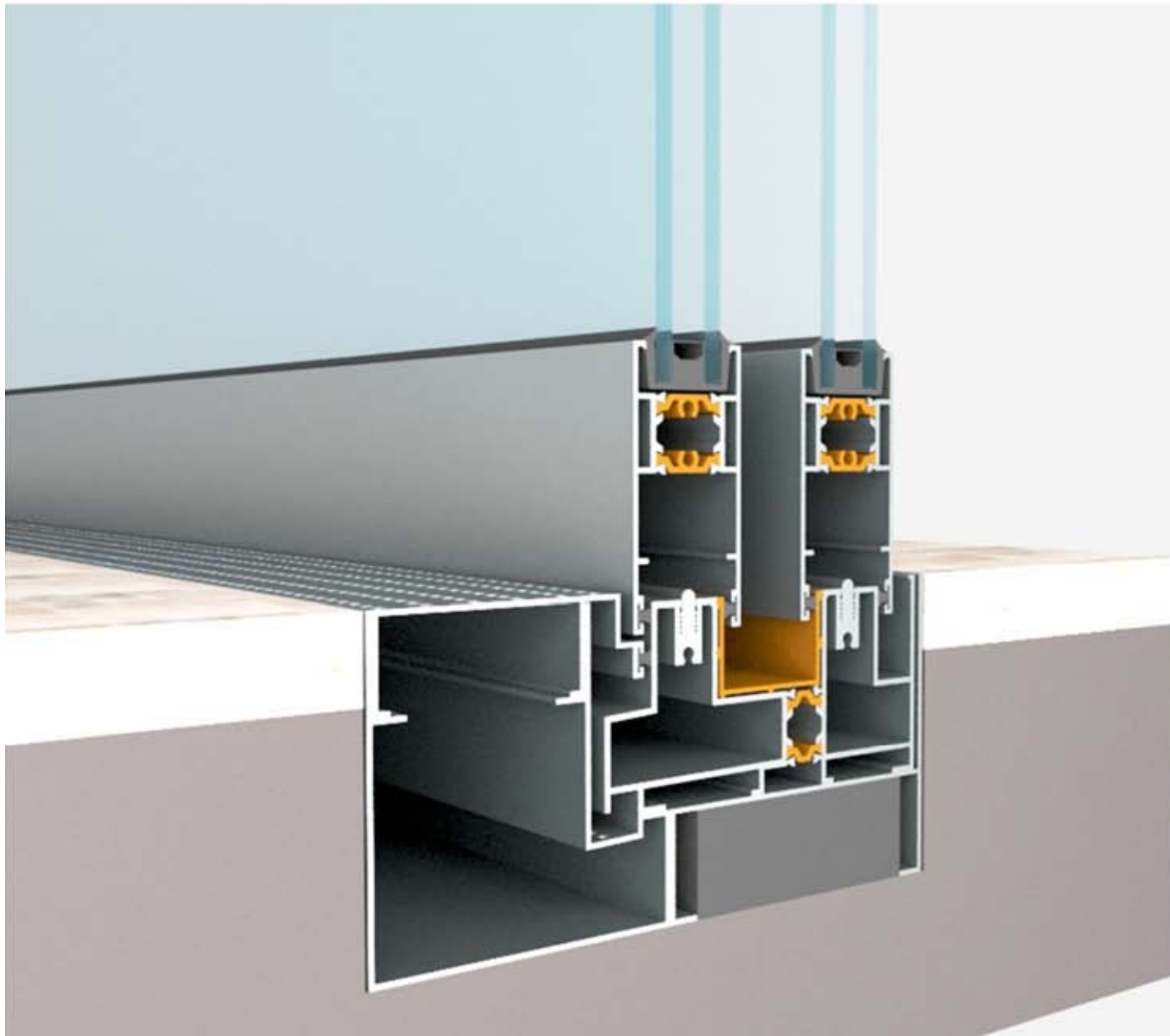

## THERMAL BREAK 2T2S INTERLOCK



FACADE ONE  
INTERNATIONAL

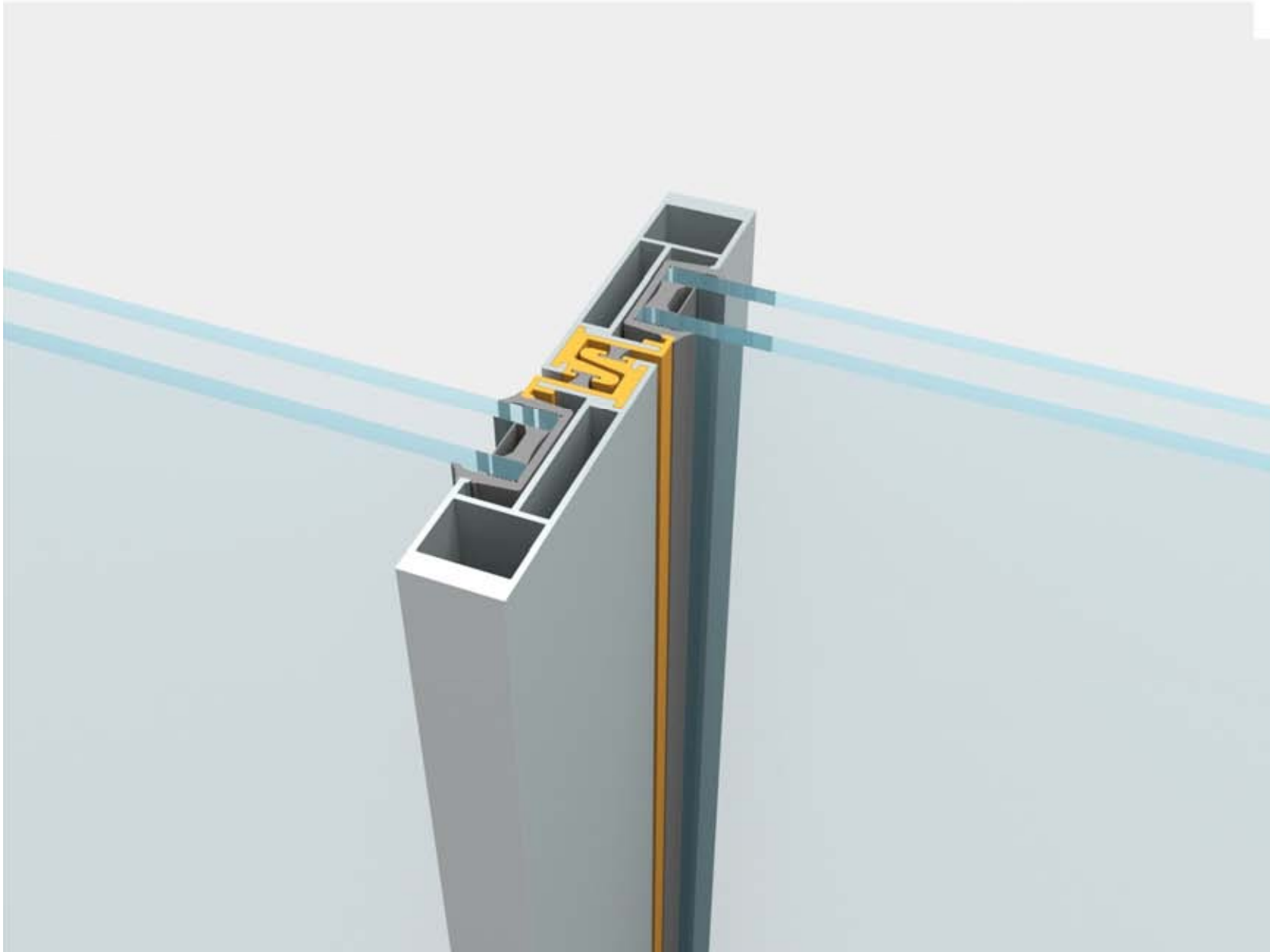

VENTILATOR WINDOW OUTSIDE VIEW



FACADE ONE  
INTERNATIONAL

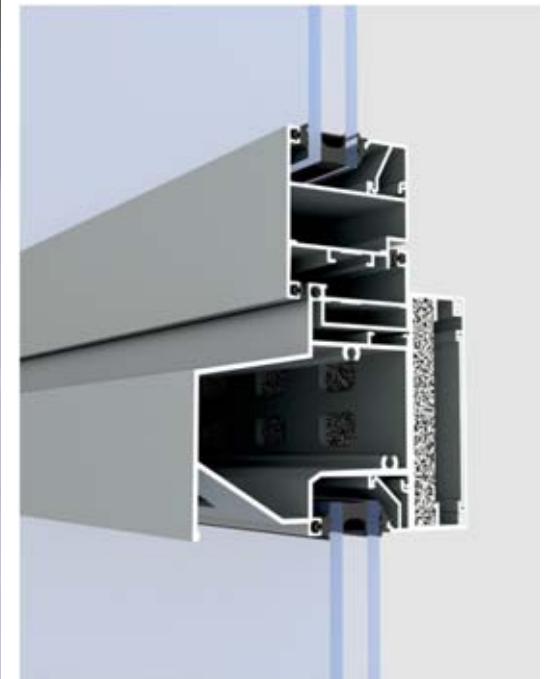

VENTILATOR WINDOW INSIDE VIEW



FACADE ONE  
INTERNATIONAL

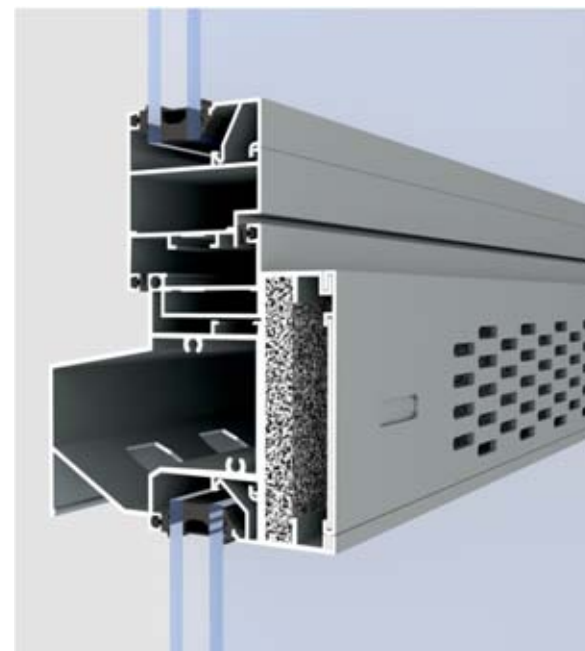



PANAROMA WINDOW



FACADE ONE  
INTERNATIONAL



PANAROMA KHALID WINDOW



PANAROMA KHALID WINDOW

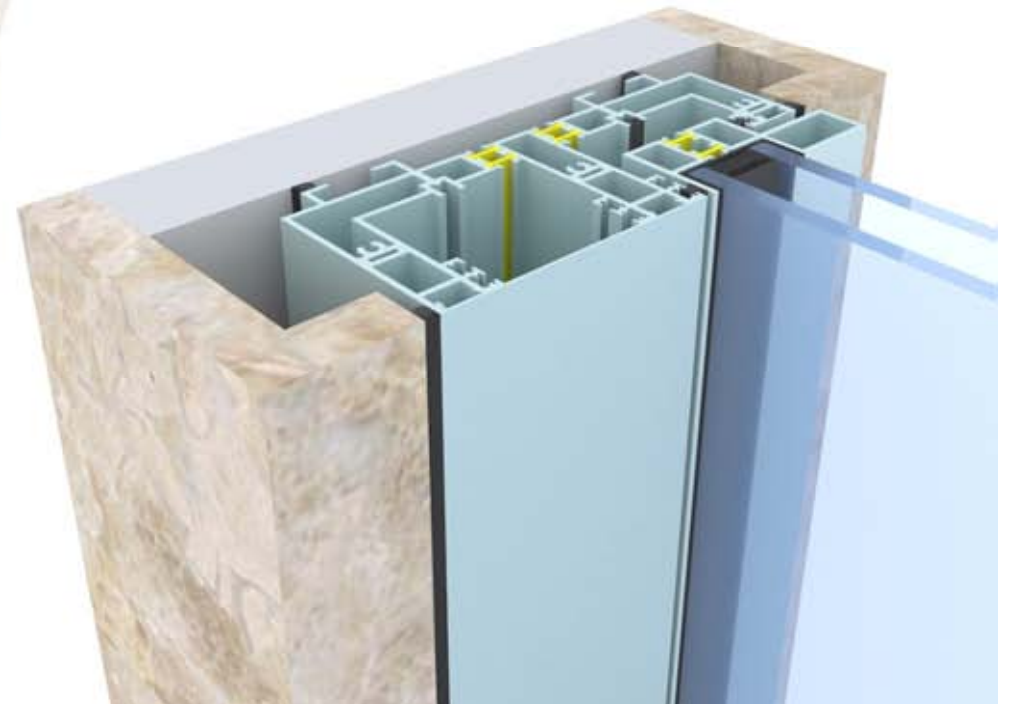
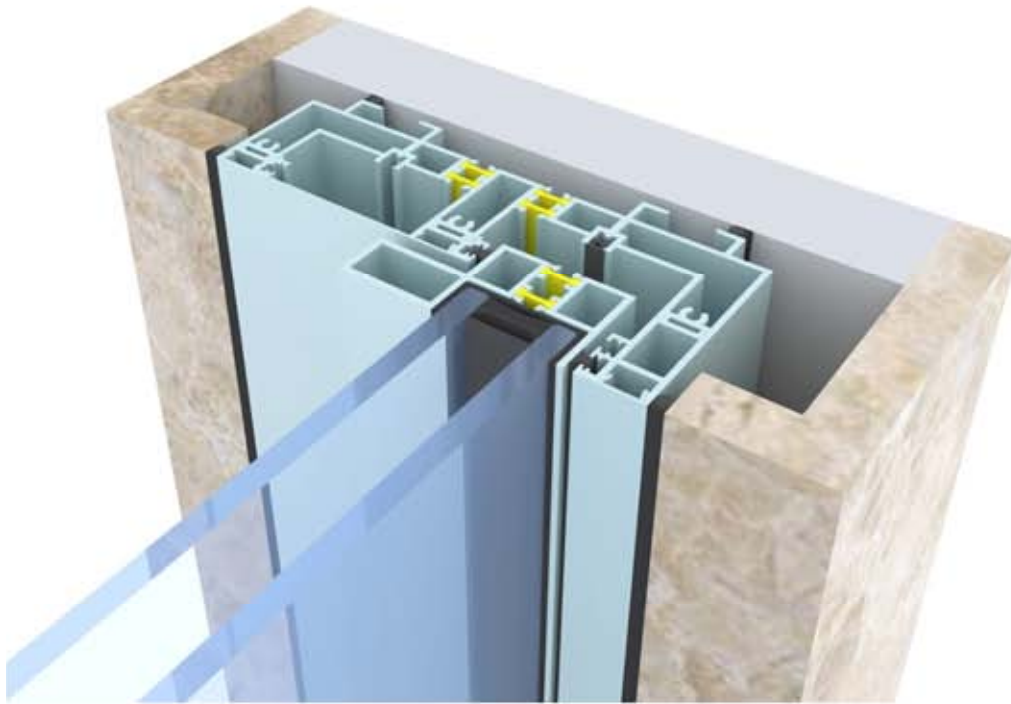

PANAROMA KHALID WINDOW



FACADE ONE  
INTERNATIONAL

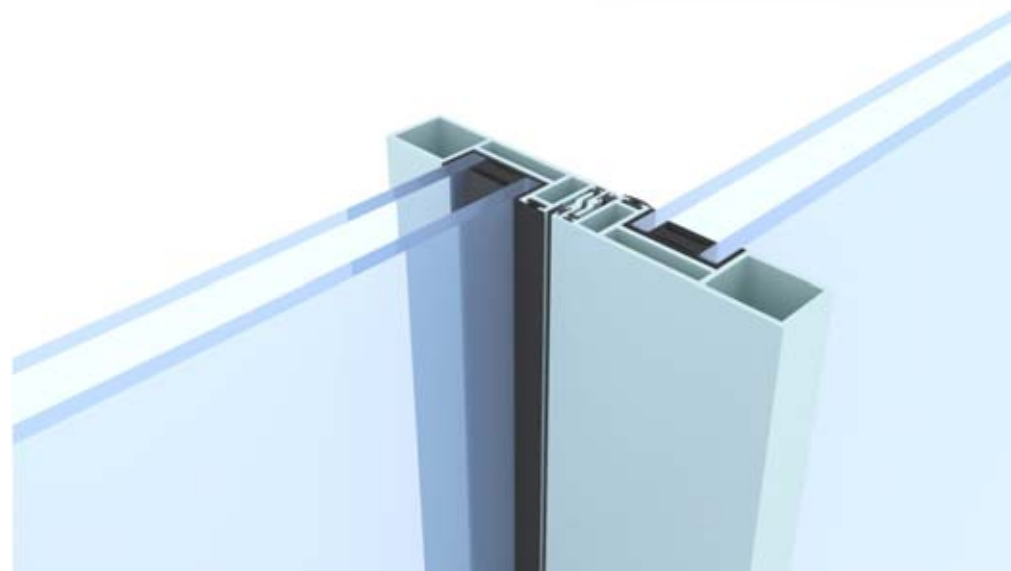
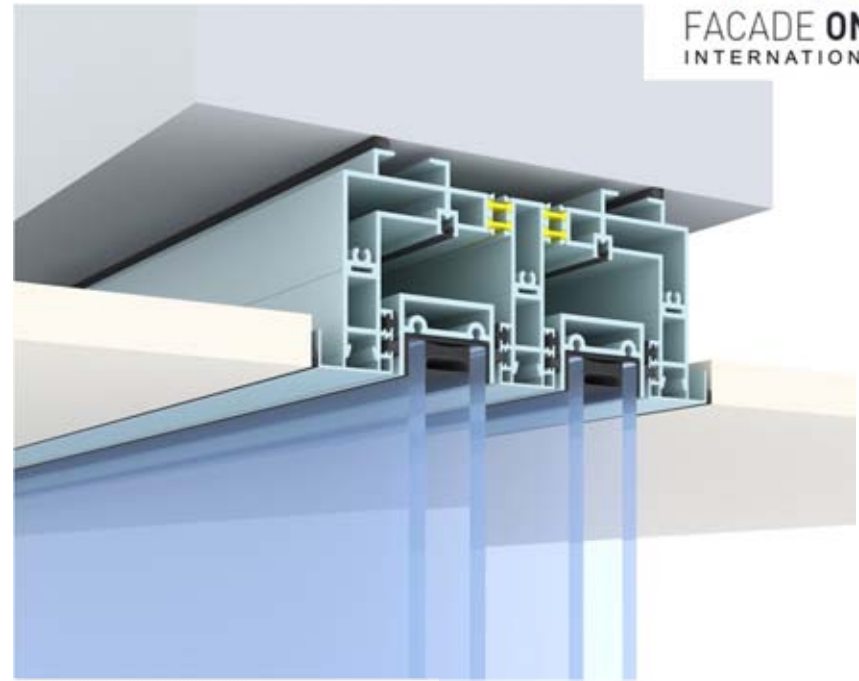
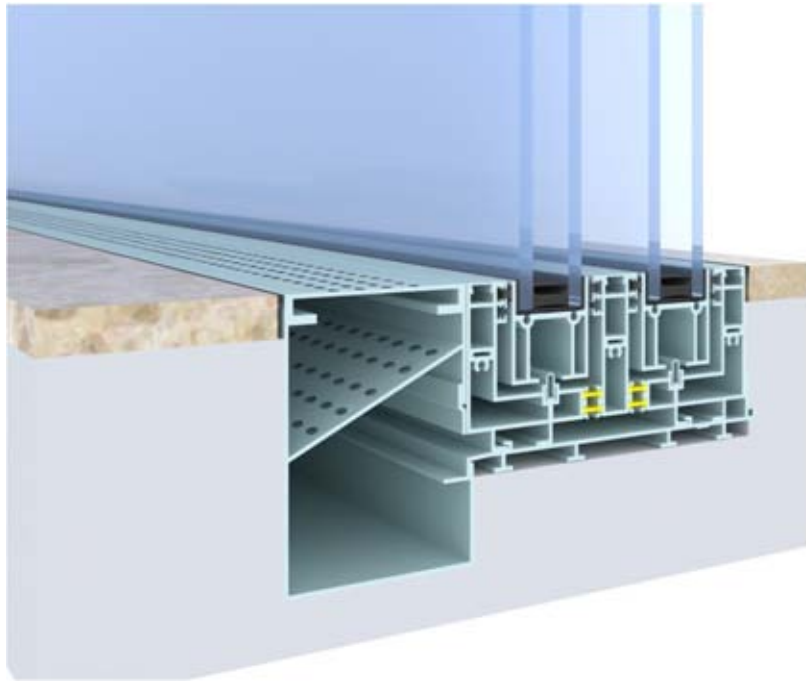



# ARCHITECTURAL LOUVERS

---

## Innovation to Architectural Imagination

## ARCHITECTURAL LOUVERS

---



FACADE ONE  
INTERNATIONAL

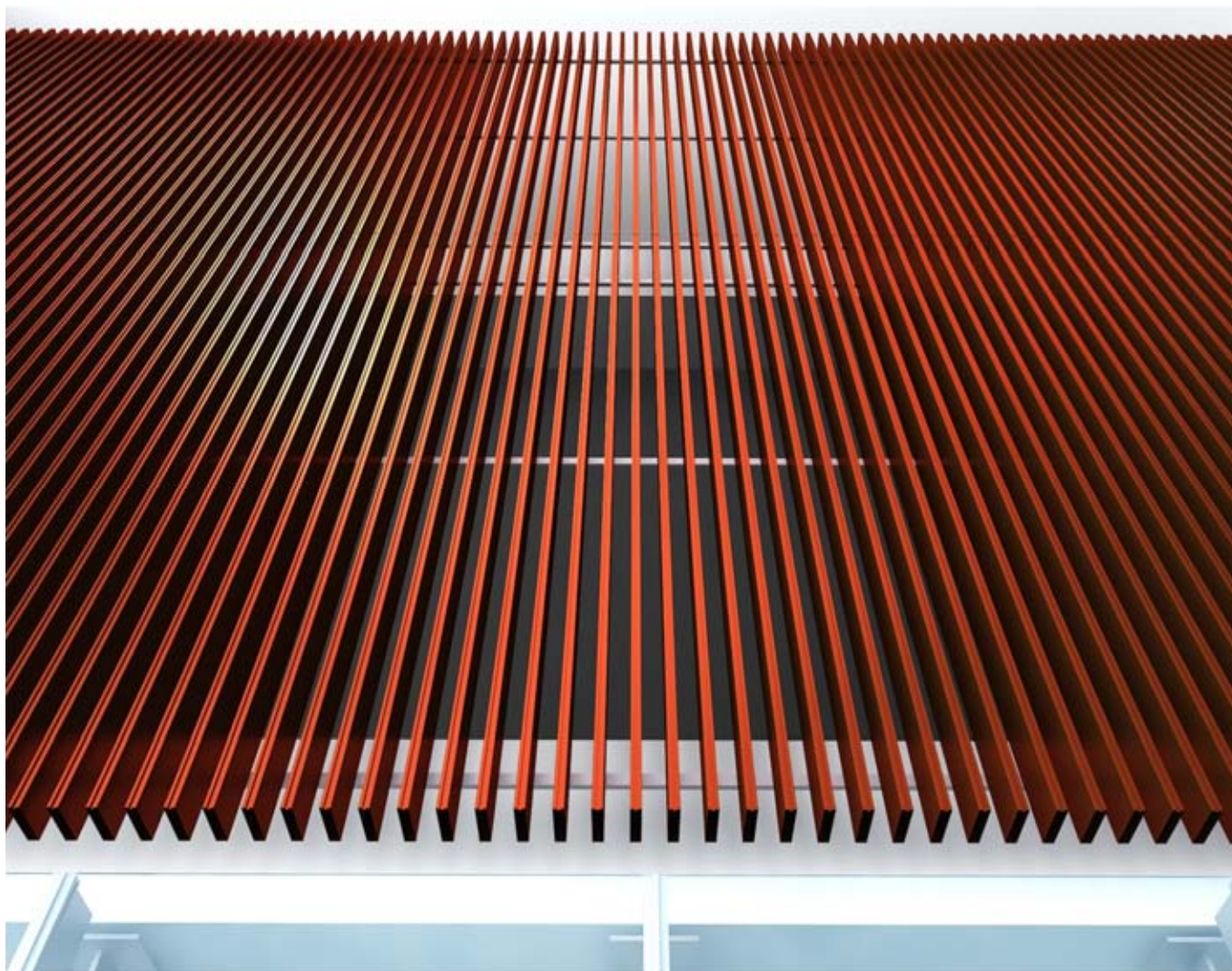

## VERTICAL FIN LOUVERS

---

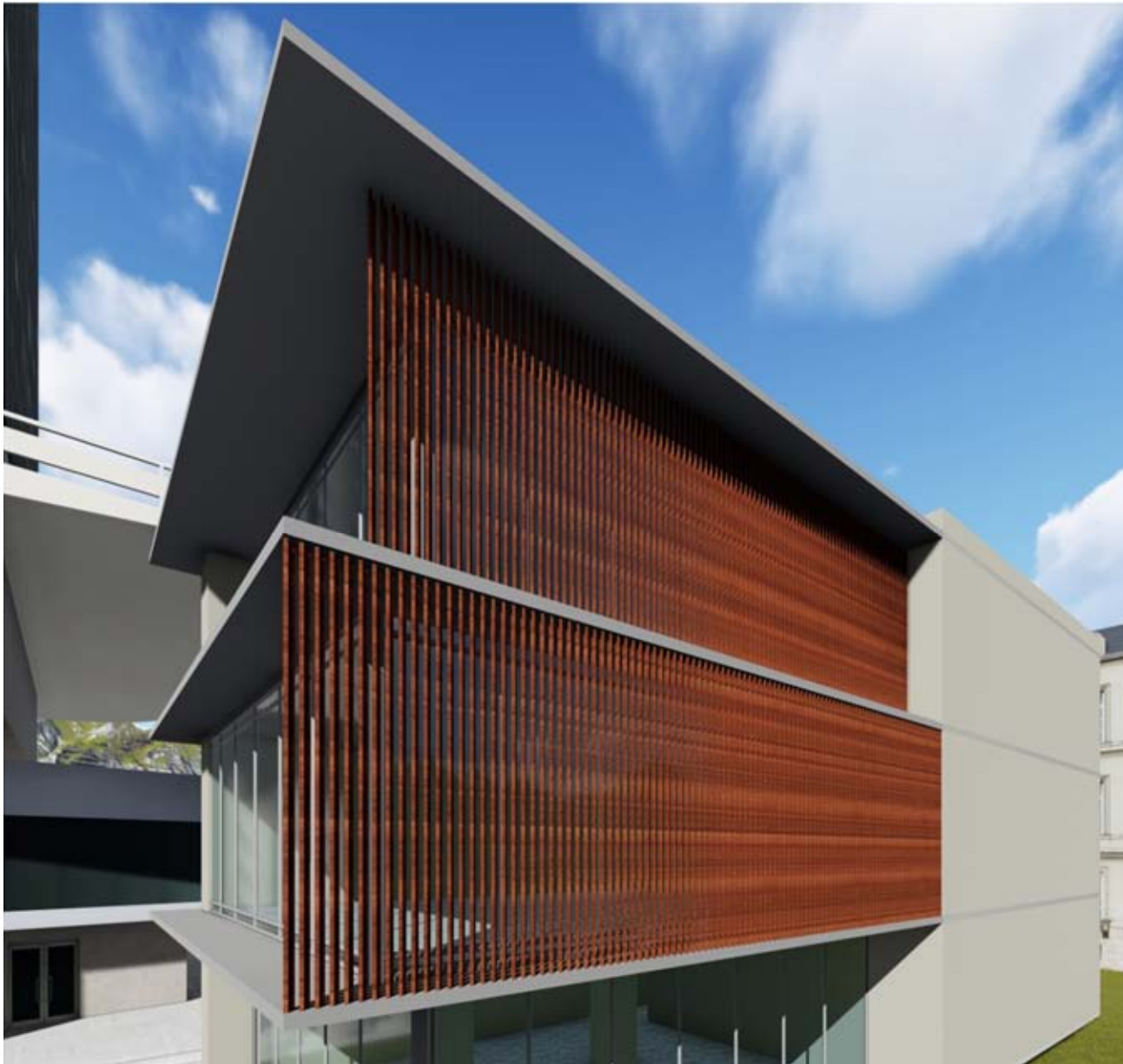

FACADE ONE  
INTERNATIONAL

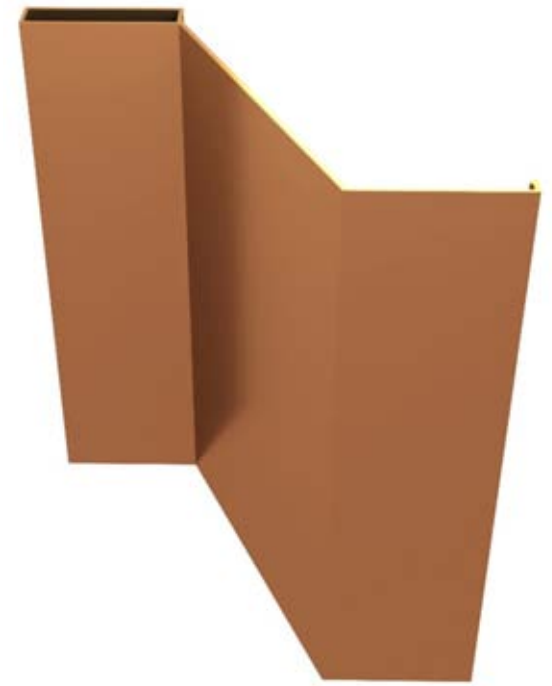





SLIDING LOUVERS







## SLIDING LOUVERS

---



# SEAMLESS RAILINGS

---

Innovation to Seamless Safety

SEAMLESS VIEW

---





FACADE ONE  
INTERNATIONAL

**BALCONY  
LED INTEGRATION**

---

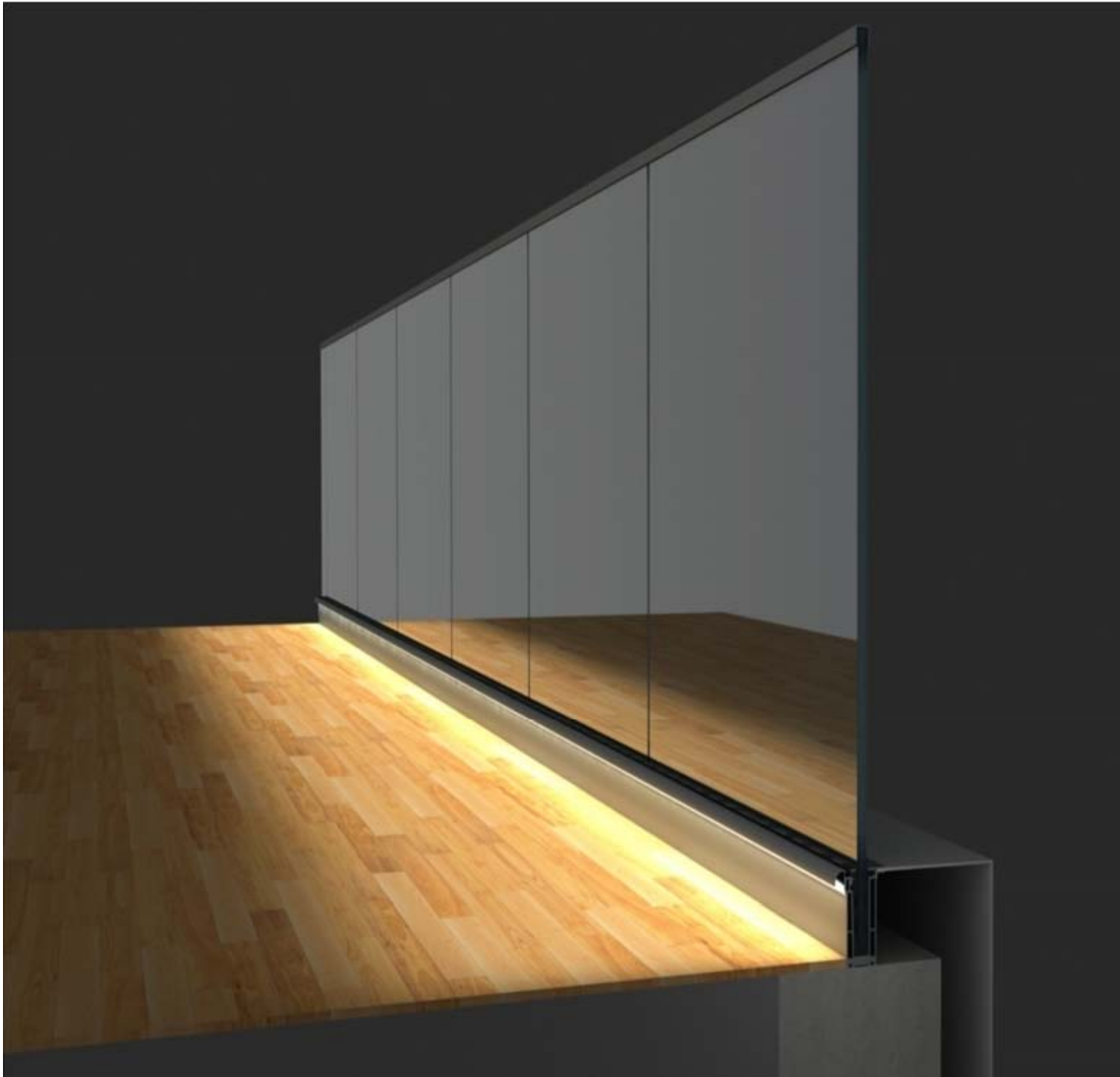



LED COVE LIGHT

---



FACADE ONE  
INTERNATIONAL



## SHARP EDGE DETAILS



FACADE ONE  
INTERNATIONAL





**LED FROM TOP**  
WASHING BALCONY

---

## INCLINED AND CURVED RAILING

---



FACADE ONE  
INTERNATIONAL





INCLUDE RAILING

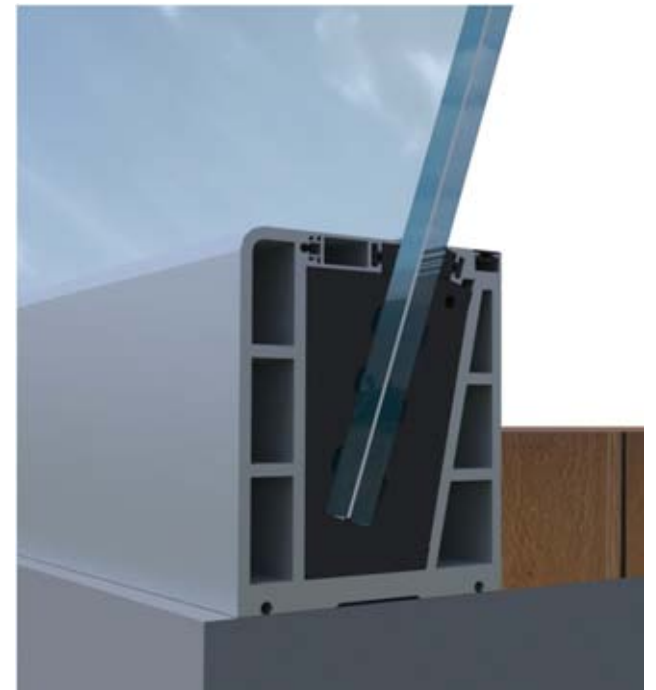

## INTEGRATED TERRACOTA

---



FACADE ONE  
INTERNATIONAL



## INTEGRATED SOLAR PANEL

---



FACADE ONE  
INTERNATIONAL

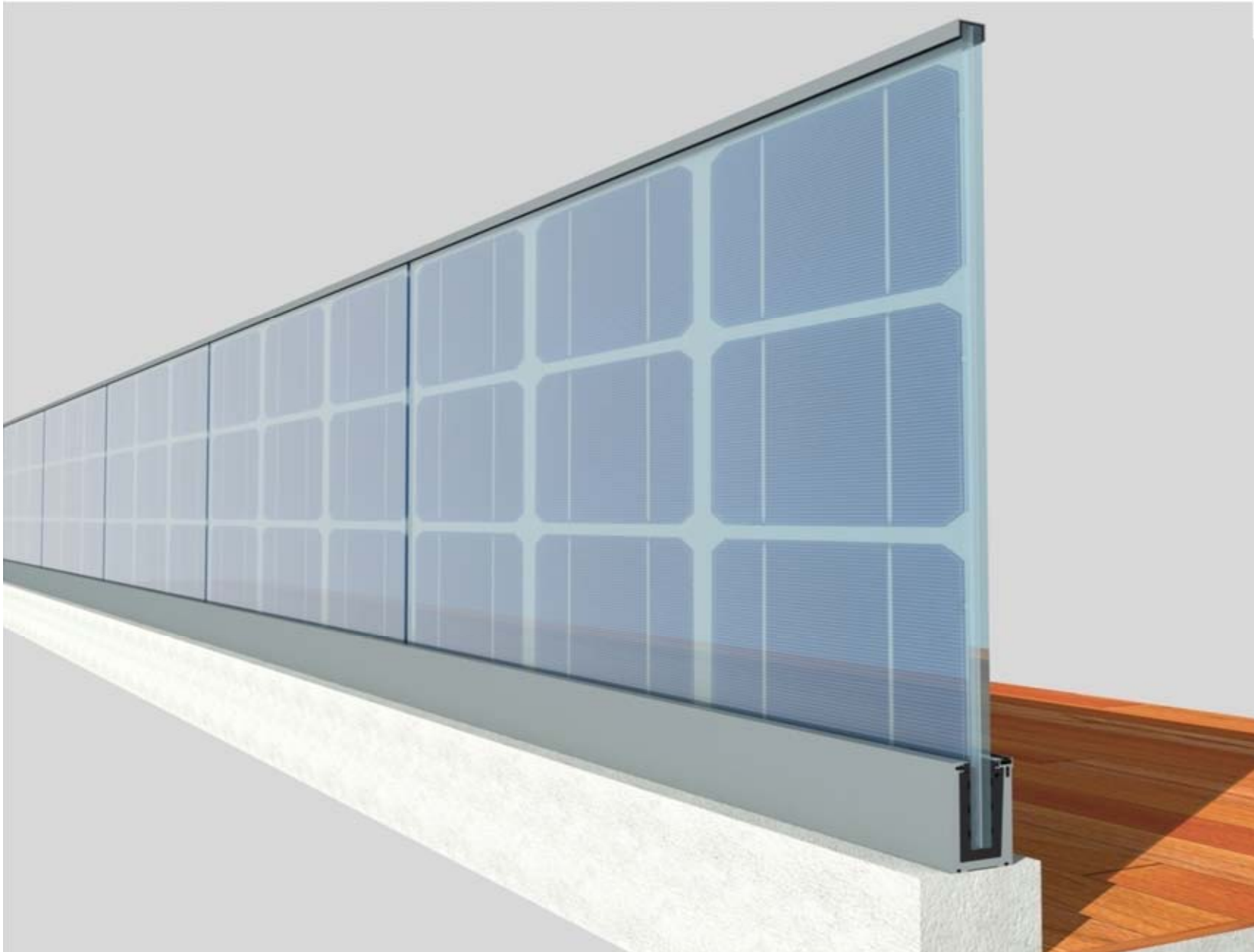



FACADE ONE  
INTERNATIONAL

## CURVED SLAB EDGE

---





## PARKING RAILING

---



FACADE ONE  
INTERNATIONAL





FACADE ONE  
INTERNATIONAL

GLASS FIXING  
INSIDE

---

## OBLONG SHAPE RAILING

---



FACADE ONE  
INTERNATIONAL

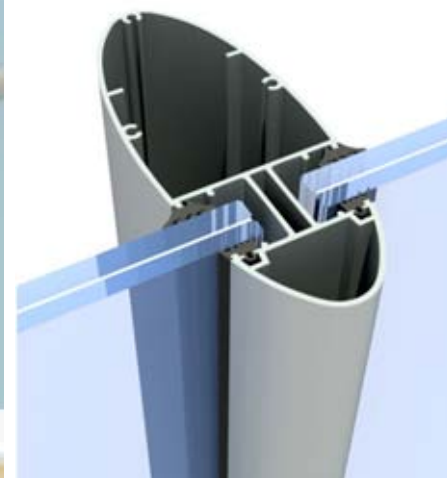

# MOVABLE SCREENS

---

Innovation to Architectural Imagination



## MOVABLE SCREEN GOLD FINISH

---



FACADE ONE  
INTERNATIONAL



## MOVABLE SCREEN GOLD FINISH

---



FACADE ONE  
INTERNATIONAL

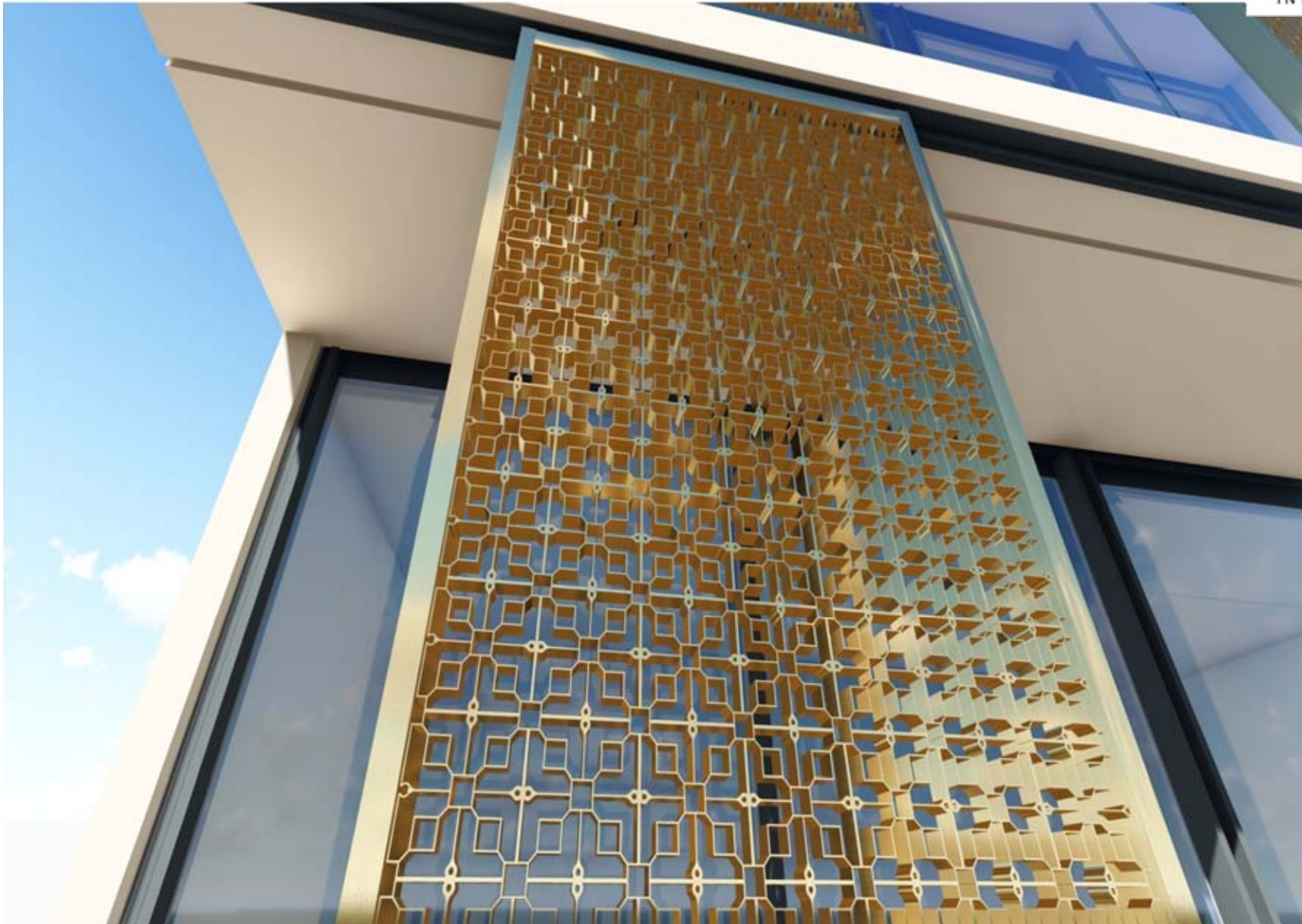



## MOVABLE SCREEN ROSE GOLD FINISH

---



FACADE ONE  
INTERNATIONAL

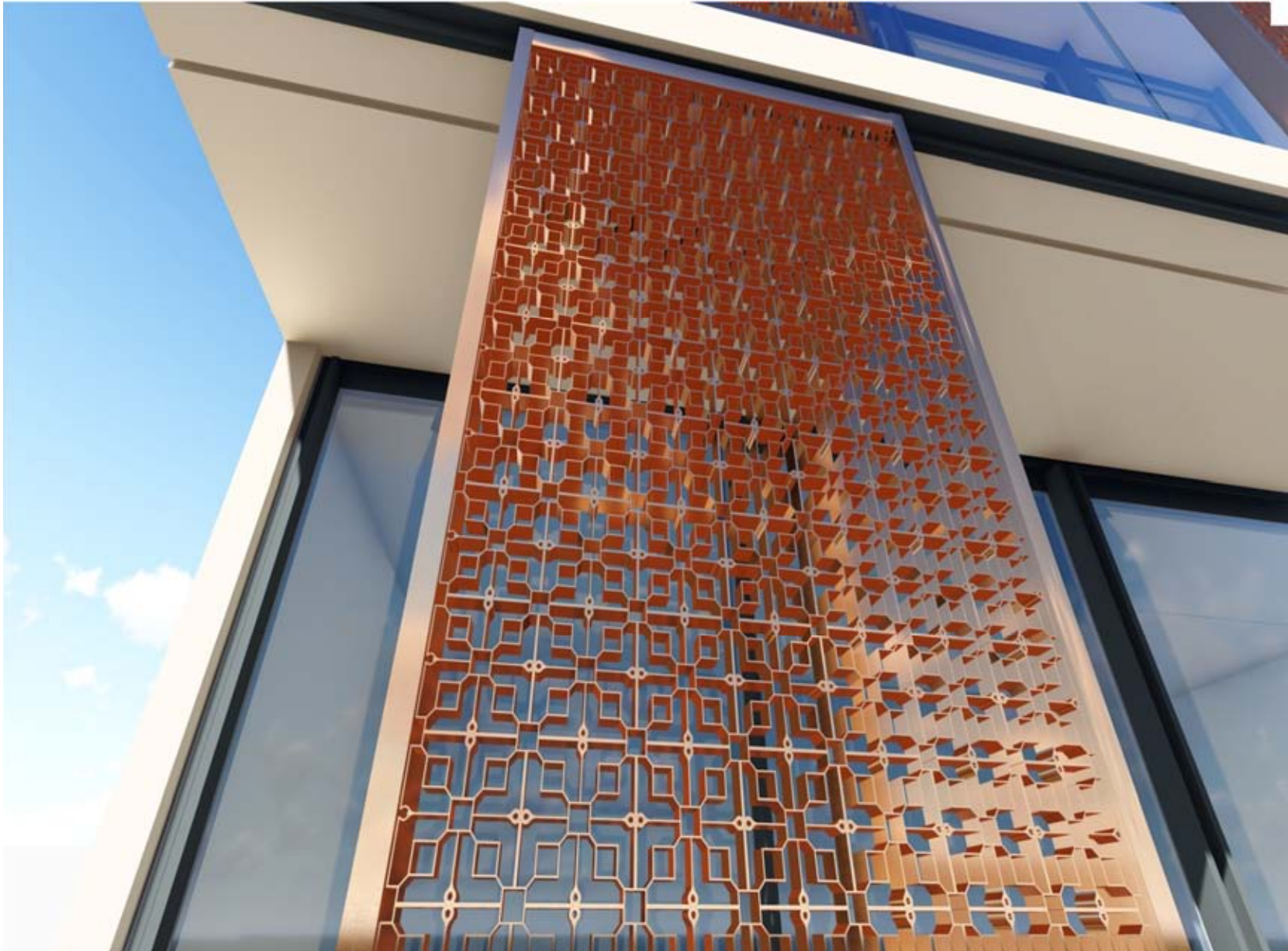

# SWISS SCREEN

---

Innovation to Architectural Imagination



# SWISS SCREEN

---

- All Aluminium 3D Screen
- 20 Designs complimenting architecture
- Exterior & Interior application
- Screen thickness can be 10mm to 60mm



FACADE ONE  
INTERNATIONAL

SWISS SCREEN

OUTDOOR SITTING







FACADE ONE  
INTERNATIONAL

## SWISS SCREEN LIVING ROOM APPLICATION





SINGLE / DOUBLE SKIN



FACADE ONE  
INTERNATIONAL

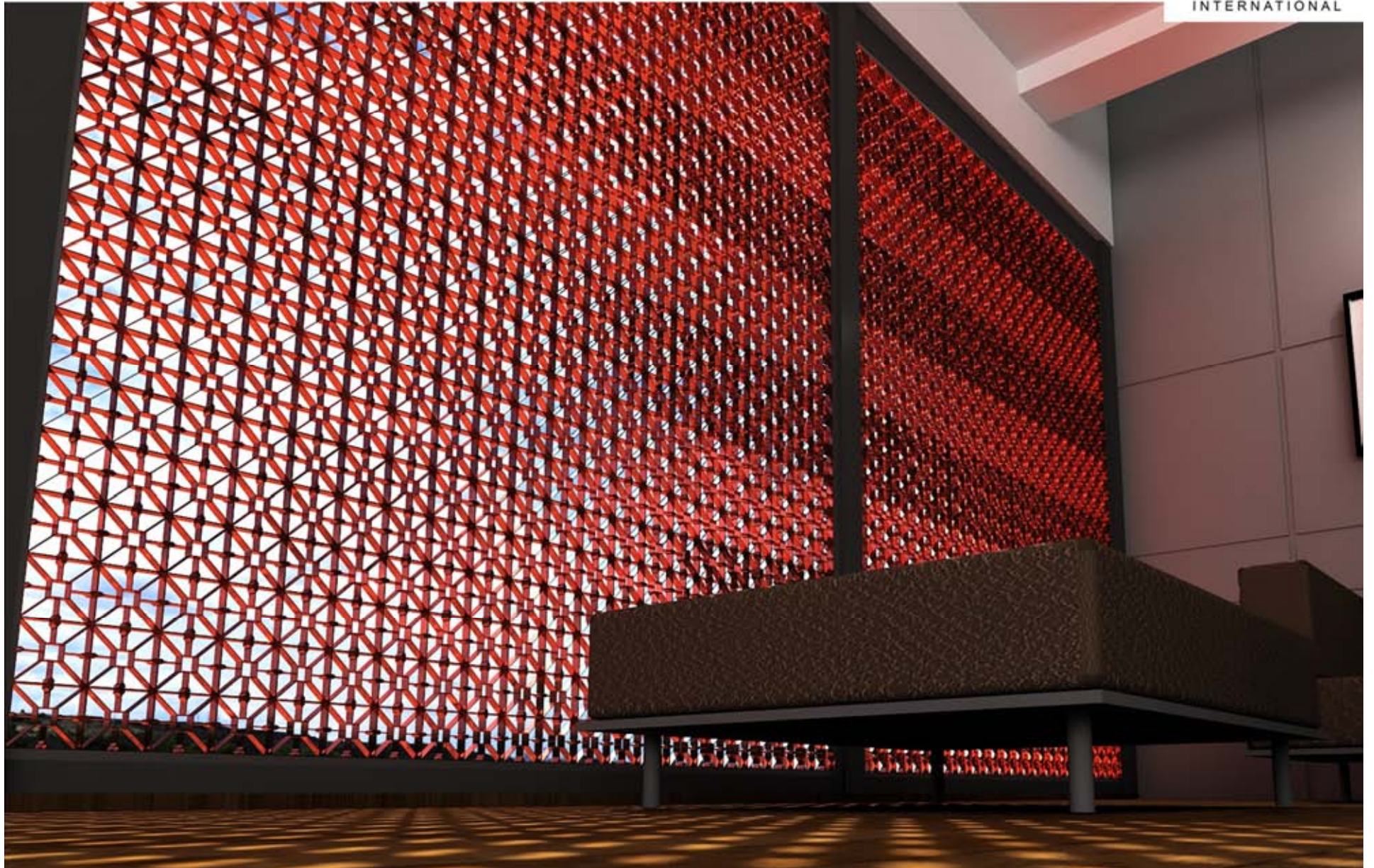



SINGLE / DOUBLE SKIN



FACADE ONE  
INTERNATIONAL

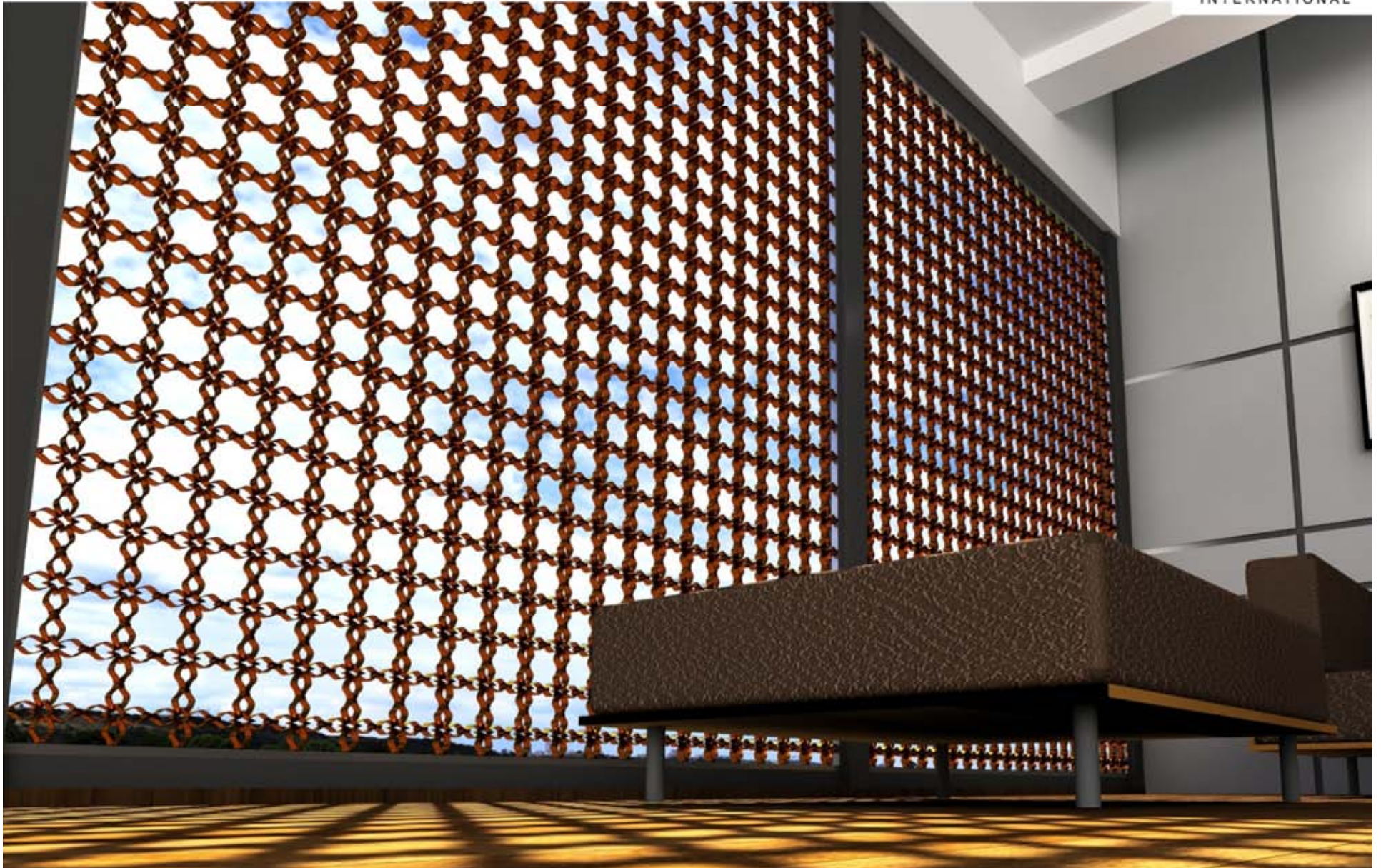



## ENTRANCE GLAZING WITH SCREEN





## ENTRANCE GLAZING WITH SCREEN



FACADE ONE  
INTERNATIONAL





## ENTRANCE GLAZING WITH NEW SCREEN



FACADE ONE  
INTERNATIONAL





SWISS SCREEN INTERIOR



FACADE ONE  
INTERNATIONAL



SWISS SCREEN INTERIOR



FACADE ONE  
INTERNATIONAL





OUTDOOR SITOUT



FACADE ONE  
INTERNATIONAL





## SWISS SCREEN

OUTDOOR PERGOLA WITH SCREEN



FACADE ONE  
INTERNATIONAL







SWISS SCREEN  
BALCONY

# SWISS SSCREEN

---

## CONNECTION DETAILS

# SWISS SCREEN

VARIANTS OF DESIGNS



FACADE ONE  
INTERNATIONAL

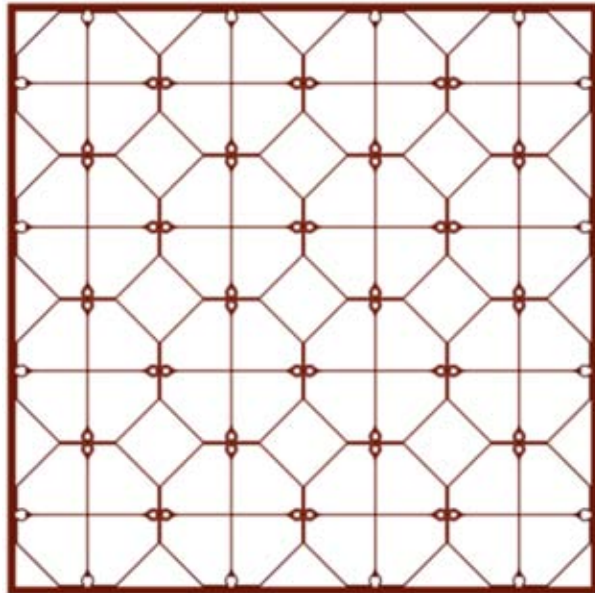

SWISS SCREEN 1

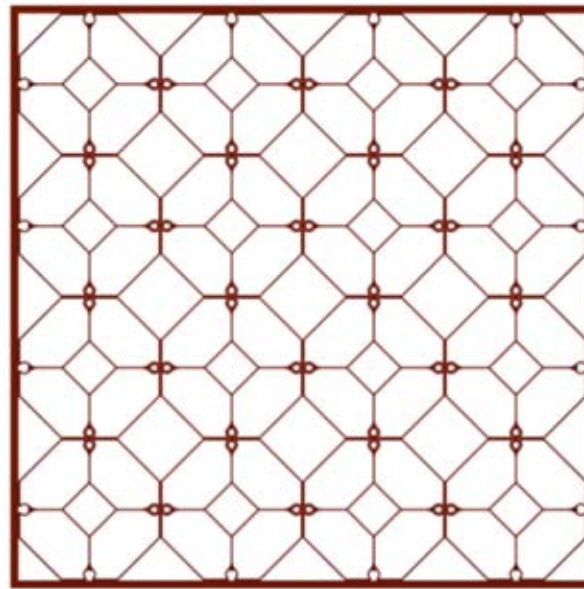

SWISS SCREEN 2

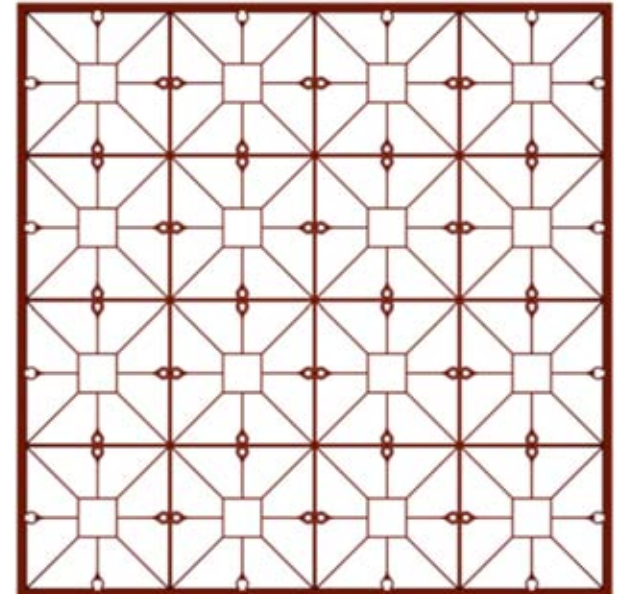

SWISS SCREEN 3

ALSO CUSTOMISED TO ARCHITECTURAL IMAGINATION



# SWISS SCREEN

VARIANTS OF DESIGNS



FACADE ONE  
INTERNATIONAL

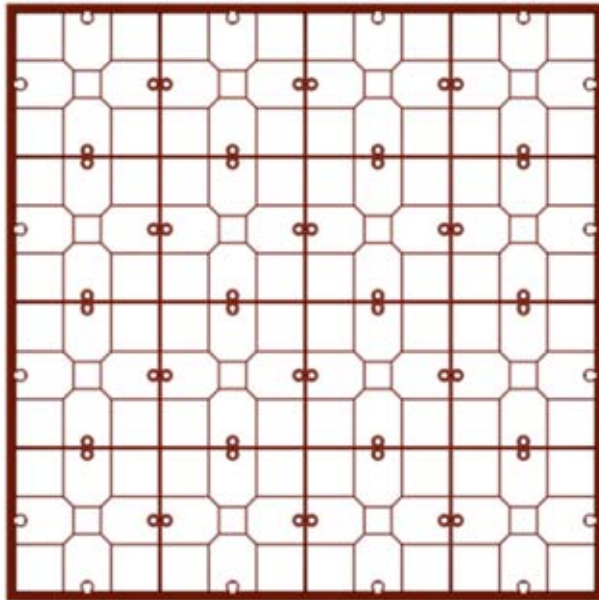

SWISS SCREEN 4

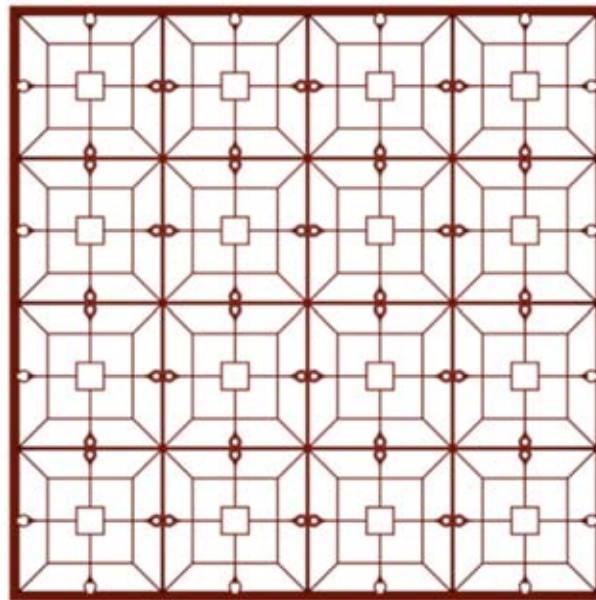

SWISS SCREEN 5

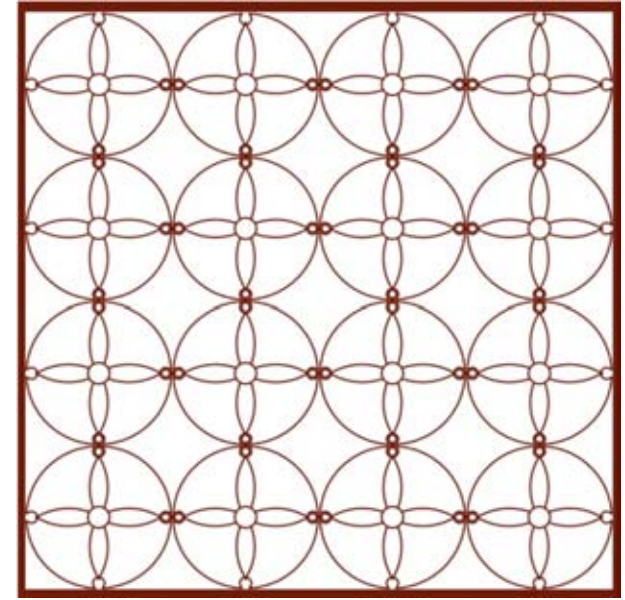

SWISS SCREEN 6

ALSO CUSTOMISED TO ARCHITECTURAL IMAGINATION

# SWISS SCREEN

VARIANTS OF DESIGNS



FACADE ONE  
INTERNATIONAL

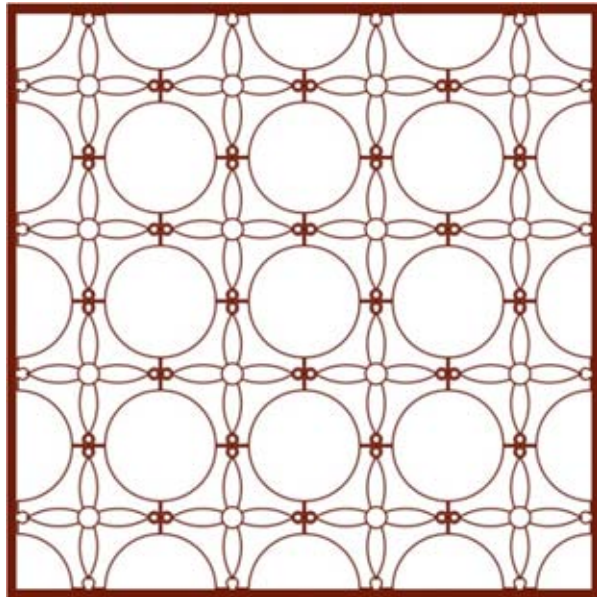

SWISS SCREEN 7

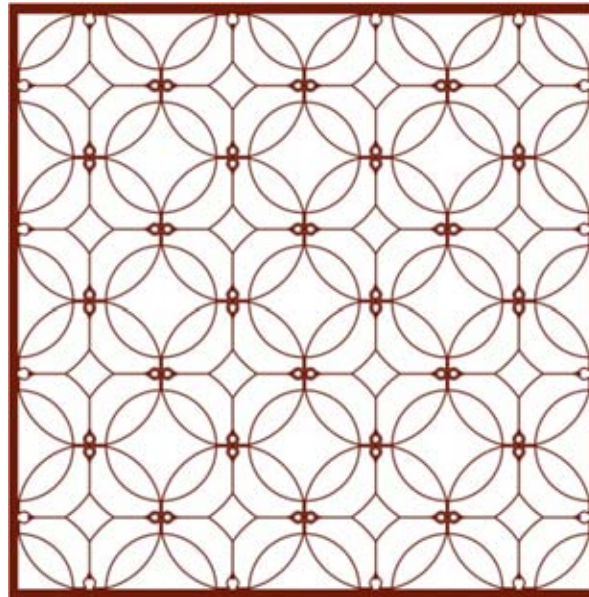

SWISS SCREEN 8

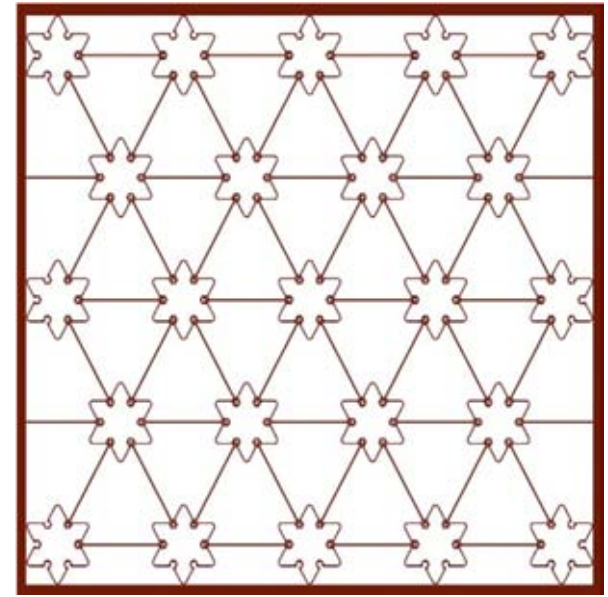

SWISS SCREEN 9

ALSO CUSTOMISED TO ARCHITECTURAL IMAGINATION

# SWISS SCREEN

VARIANTS OF DESIGNS



FACADE ONE  
INTERNATIONAL

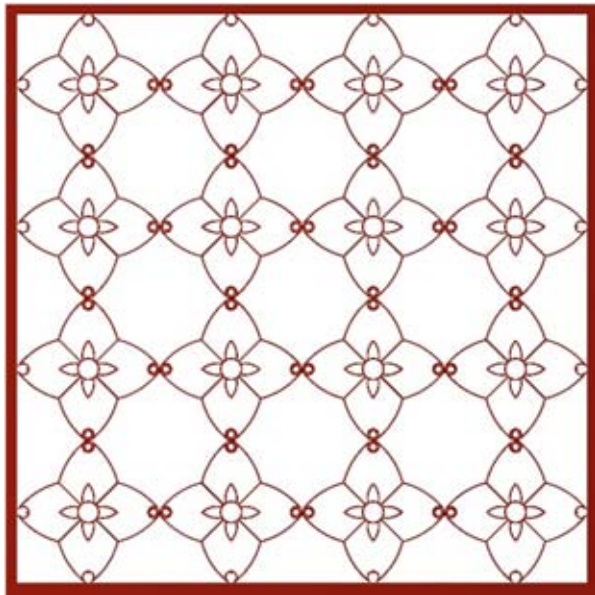

SWISS SCREEN 10

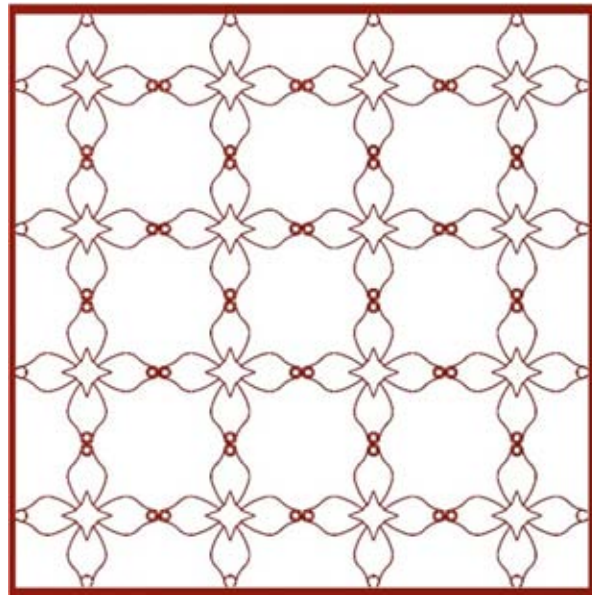

SWISS SCREEN 11

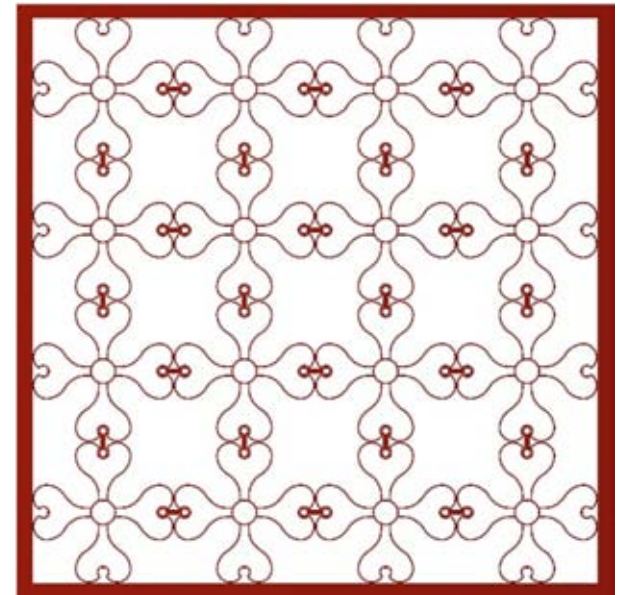

SWISS SCREEN 12

ALSO CUSTOMISED TO ARCHITECTURAL IMAGINATION



# SWISS SCREEN

VARIANTS OF DESIGNS



FACADE ONE  
INTERNATIONAL

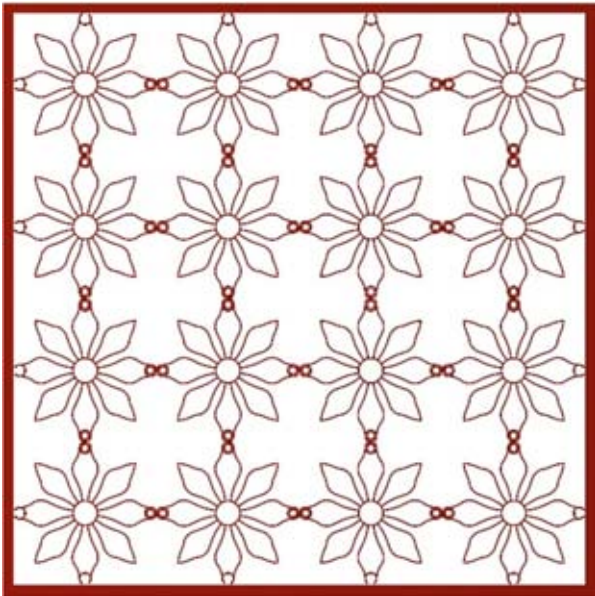

SWISS SCREEN 13

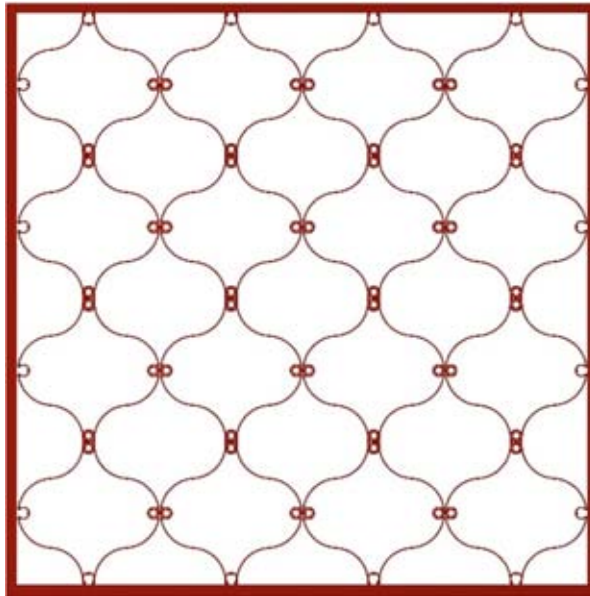

SWISS SCREEN 14

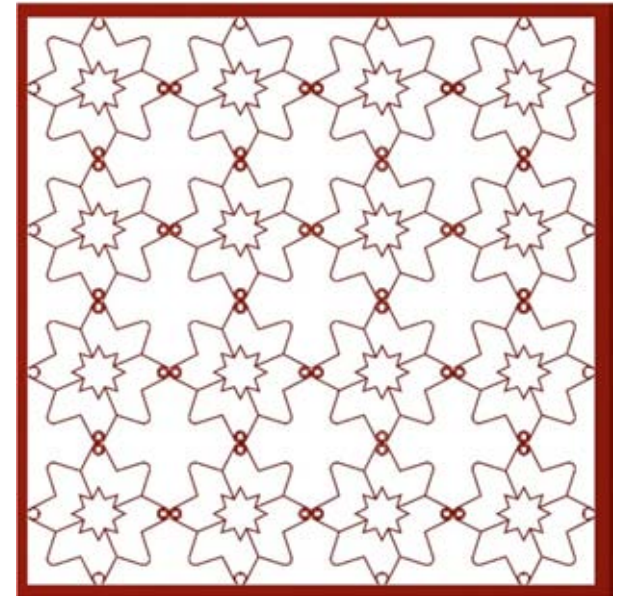

SWISS SCREEN 15

ALSO CUSTOMISED TO ARCHITECTURAL IMAGINATION

## SWISS SCREEN

SOME FINISHES



FACADE ONE  
INTERNATIONAL

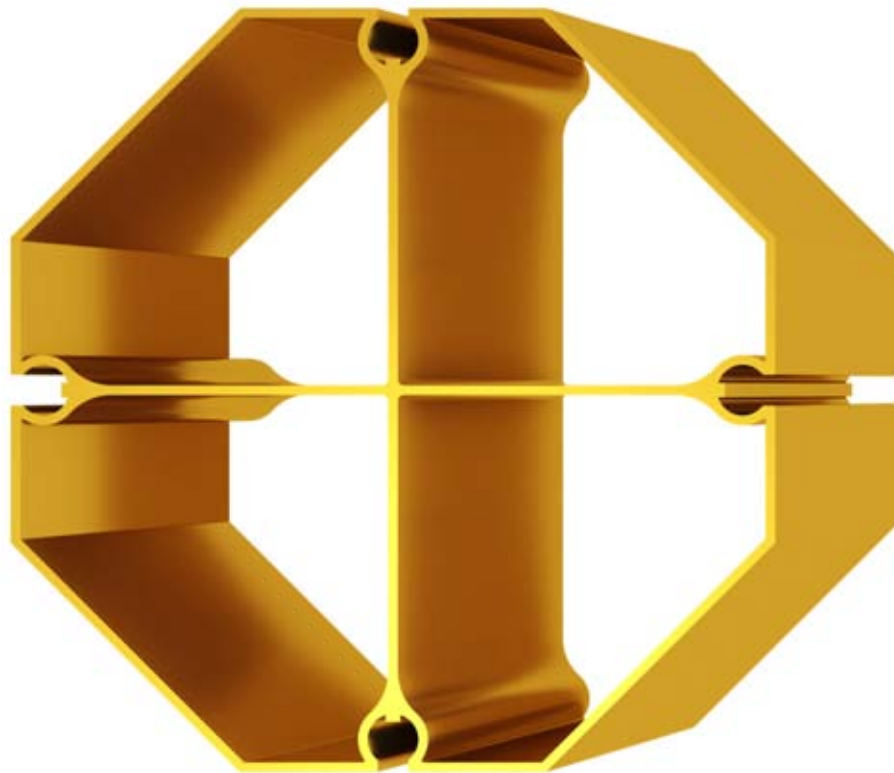

DESIGN 1

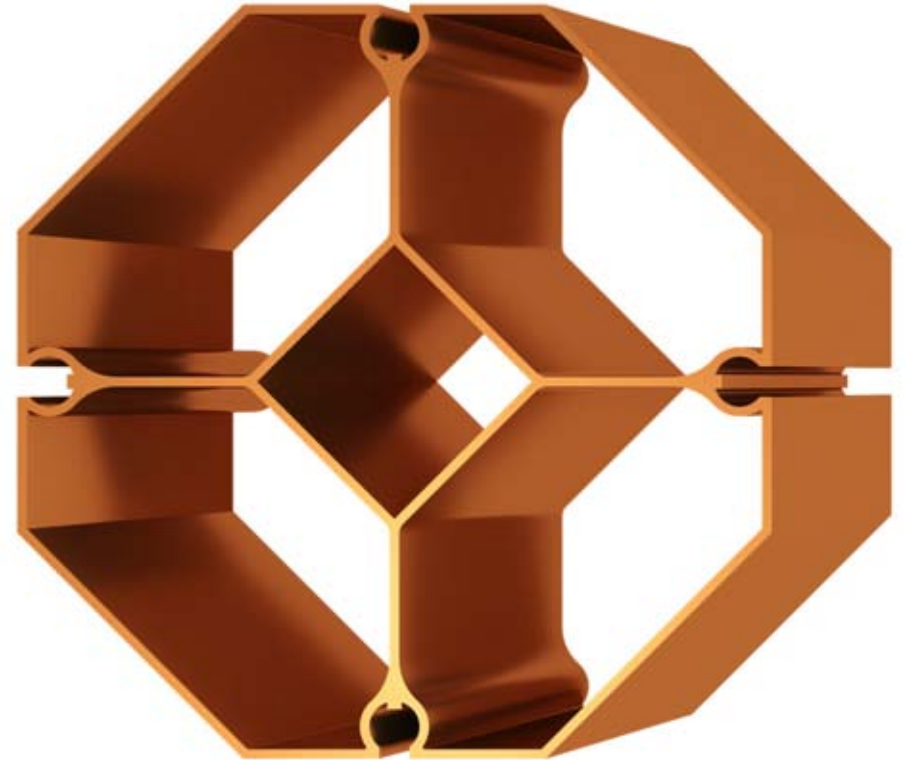

DESIGN 2

ALSO CUSTOMIZED TO DIFFERENT FINISHES

## SWISS SCREEN

SOME FINISHES



FACADE **ONE**  
INTERNATIONAL

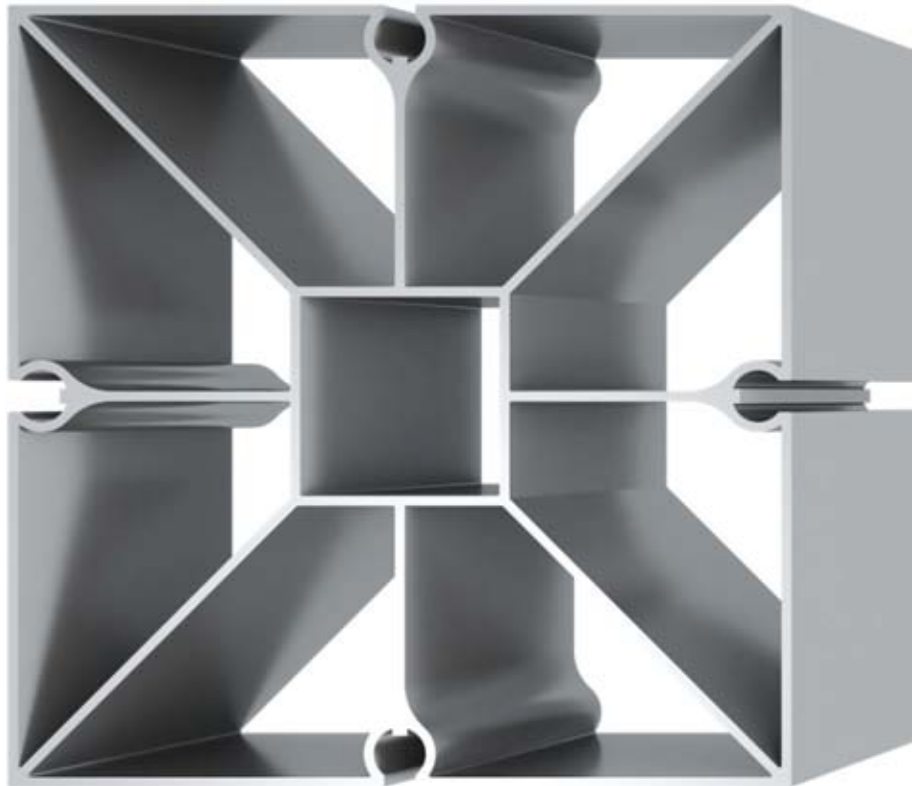

DESIGN 3



DESIGN 9

ALSO CUSTOMIZED TO **DIFFERENT FINISHES**



## SWISS SCREEN

SOME FINISHES



FACADE ONE  
INTERNATIONAL

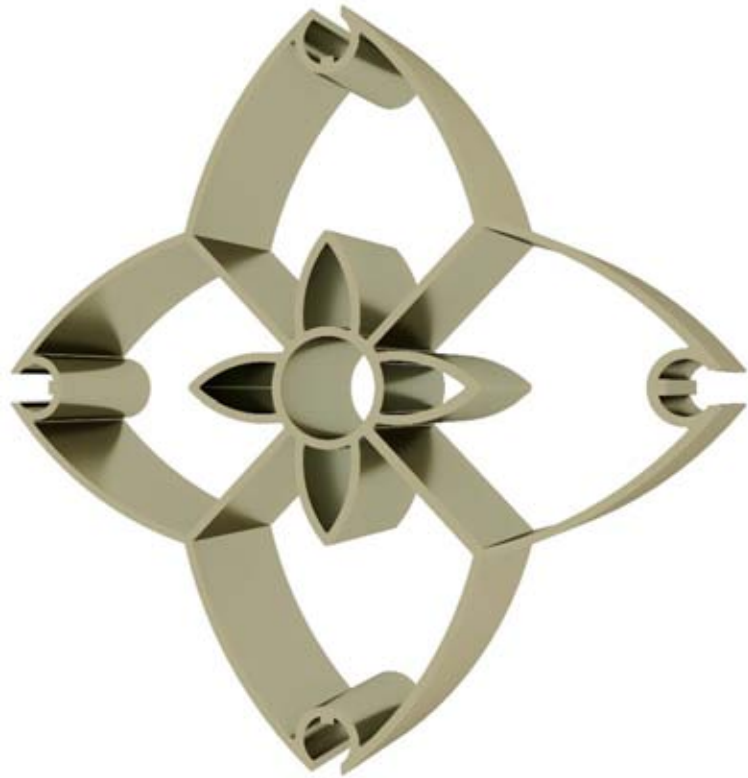

DESIGN 10



DESIGN 11

ALSO CUSTOMIZED TO DIFFERENT FINISHES

## SWISS SCREEN

SOME FINISHES



FACADE ONE  
INTERNATIONAL



DESIGN 13

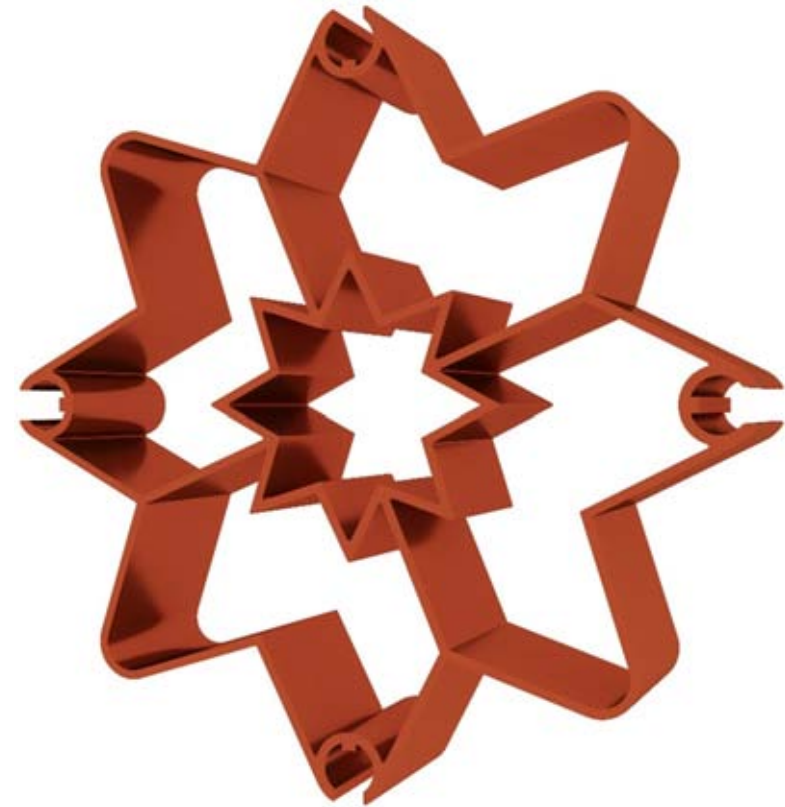

DESIGN 15

ALSO CUSTOMIZED TO DIFFERENT FINISHES

## SWISS SCREEN

SOME FINISHES



FACADE ONE  
INTERNATIONAL



ALSO CUSTOMIZED TO DIFFERENT FINISHES



# SWISS SCREEN

SOME FINISHES



FACADE ONE  
INTERNATIONAL

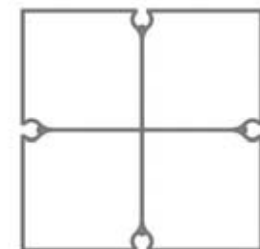
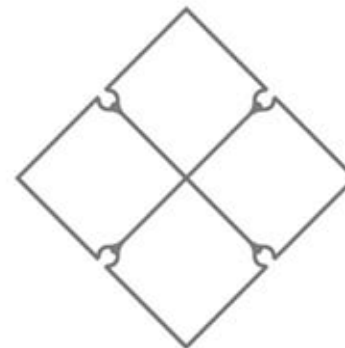
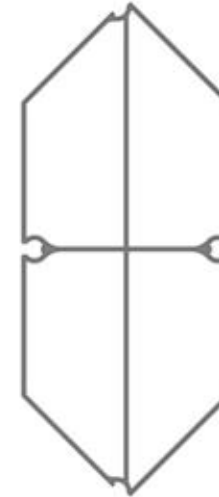
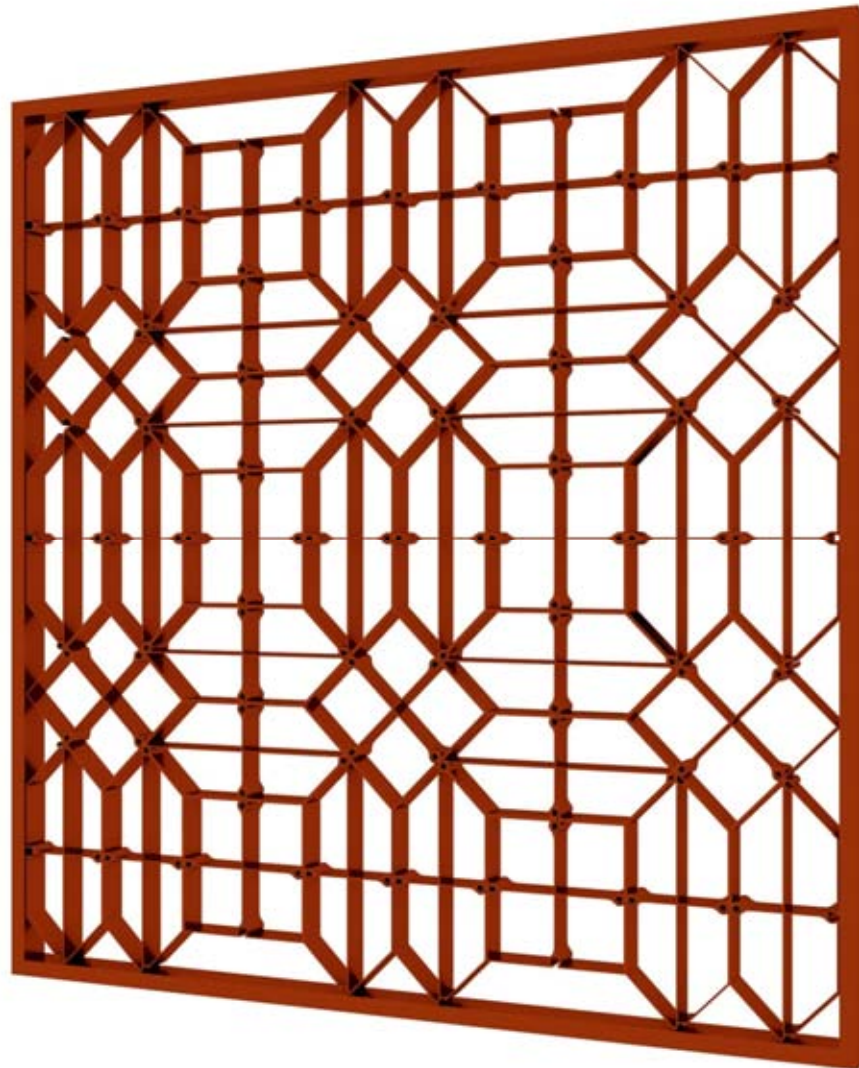

ALSO CUSTOMIZED TO DIFFERENT FINISHES

## SWISS SCREEN

SOME FINISHES



FACADE ONE  
INTERNATIONAL

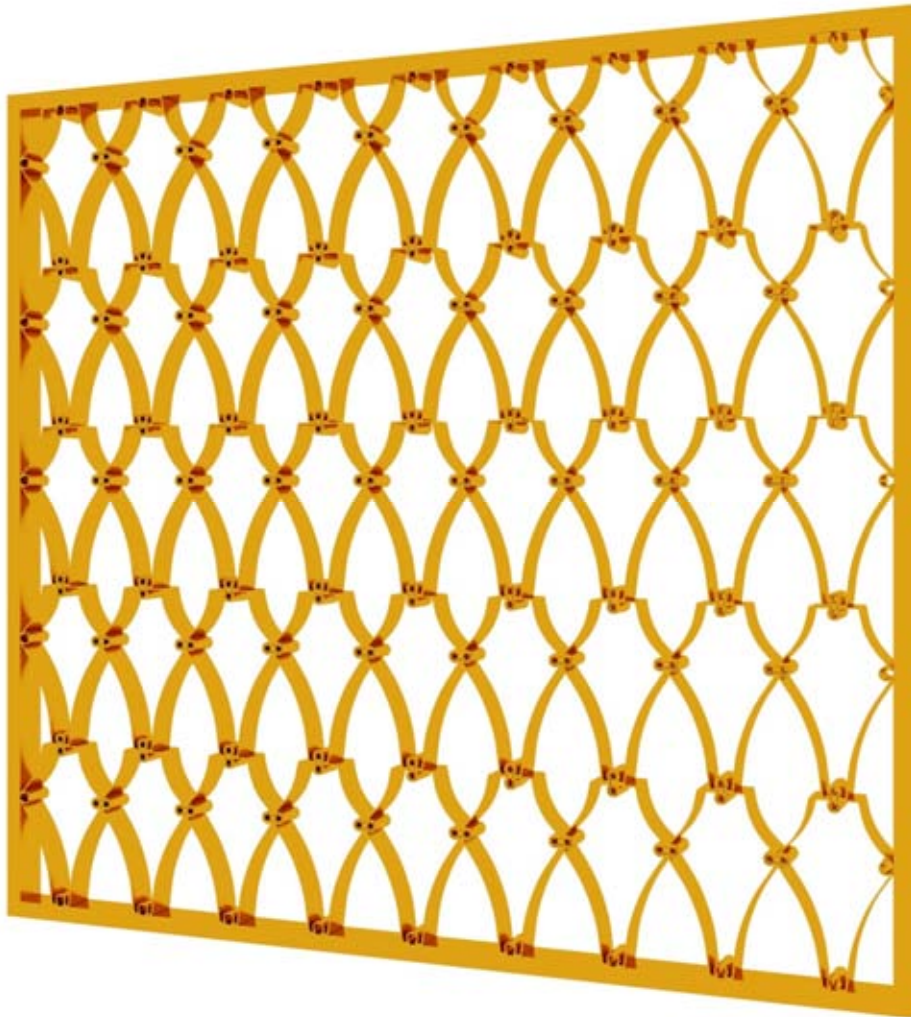

ALSO CUSTOMIZED TO DIFFERENT FINISHES

## SWISS SCREEN

SOME FINISHES



FACADE **ONE**  
INTERNATIONAL



ALSO CUSTOMIZED TO DIFFERENT FINISHES





# BAFFEL DESIGNS

---

# ARCHITECTURAL CEILING



FACADE ONE  
INTERNATIONAL



## ARCHITECTURAL CEILING



FACADE ONE  
INTERNATIONAL





# ARCHITECTURAL CEILING



FACADE ONE  
INTERNATIONAL



# ARCHITECTURAL CEILING



FACADE ONE  
INTERNATIONAL



# SELECTED WORKS

---





Project : CEEBROS ONE74

Client : CEEBROS

Architect : RMA

F1 System : INFINITY Sliding System 10000 m<sup>2</sup> ,  
Seamless Railing 10,000 m<sup>2</sup>

Completion By : DEC 2017





Project : DY PATIL UNIVERSITY, MUMBAI  
Client : DY PATIL GROUP  
Architect : FOSTER + PARTNERS  
F1 system : INFINITY sliding system 12000 m<sup>2</sup>  
Facade contractor : ANGEL FAÇADE SYSTEM  
Completion by : 2018







Project : KOHINOOR SQUARE ( 205mtr tall ) Commercial  
Client : KCTNL Mumbai  
Architect : GKK Works & SAA Mumbai  
F1 System : Articulated Unitized curtain wall system 96000 m<sup>2</sup>  
Facade contractor : Glass Wall Mumbai  
Completion : By Dec 2018







Project : ALTAIR Colombo. Residential 284m tall  
Client : Indocean Developer Pvt Ltd  
Architect : Mosse Safdie  
F1 System : Baluster & Seamless Railing 6000 Rmt  
Facade contractor : Nitson & Amitsu Kolkata  
Completion By : Dec 2018







Project : BRIGADE WTC Bangalore - 128 mtr tall Commercial  
Client : Brigade Enterprise Ltd  
Architect : HOK & Venkatraman Associates  
F1 System : Skewed Unitised curtainwall system 52000 m<sup>2</sup>  
Facade contractor : SP Fab Mumbai  
Completion By : Dec 2012



Project : BRIGADE WTC Bangalore - 128mtr tall Commercial

Client : Brigade Enterprise Ltd

Architect : HOK & Venkatraman Associates

F1 System : Skewed Unitized curtain wall system 52000 m<sup>2</sup>

Facade contractor : SP Fab Mumbai

Completion By : Dec 2012







Project : SHERATON HOTEL Colombo  
Client : Lanka Hotel & Residences Ltd.  
Architect : ATKINS  
F1 System : Unitized Strip glazing system 12000m2  
Facade contractor : Glass Wall Mumbai  
Completion By : January 2016





Project : WORLD TRADE TOWER, Noida -  
Client : Brigade Enterprise Ltd  
Architect : NEB, DUBAI  
F1 System : Unitized curtain wall system 42000m<sup>2</sup>  
Facade contractor : True Wall System  
Completion By : March 2016





Project : KARLE TOWN CENTRE, Bangalore -  
Client : Karle Infra  
Architect : MERGE STUDIOS  
F1 System : Unitized curtain wall system 22000m2  
Facade contractor : SP FAB  
Completion By : December 2015







Project : RAMUNUJAN IT CITY  
Client : TRILL INFO PARK LTD  
Architect : EDIFICE ARCHITECTS  
F1 System : Unitized curtain wall system 15000 m2  
Facade contractor : NOBLE GLAZING  
Completion By : MAY 2015





Project : HNH Hospital, Mumbai -  
Client : RELIANCE INDUSTRIES LTD  
Architect : PERKIN + WILL USA  
F1 System : Unitized curtain wall system 20000m2  
Facade contractor : MS ENGINEERS  
Completion By : OCTOBER 2014







Project : WAVE ONE , NOIDA -  
Client : WAVE GROUP  
Architect : NOSTRI ARCHITECTS USA  
F1 System : Unitized curtain wall system 47000m2  
Facade contractor : GLASS WALL  
Completion By : FEB 2018





Project : SKAV 909 , BANGALORE -  
Client : SKAV PROPERTIES  
Architect : TEAM 2  
F1 System : Unitized curtain wall system 15000m2  
Facade contractor : ENVELOPES  
Completion By : July 2016



Project : SYNERGY 2 -  
Client : KALPATARU HOMES LTD  
Architect : AEDAS PTE LTD  
F1 System : Unitized System 13000 m2  
Facade contractor : AZAD FAÇADE  
Completion By : FEB 2015







Project : TCS, PUNE  
Client : OMKAR REALTORS  
Architect : EDIFICE CONSULTANTS  
F1 System : Unitized System 15000 M2  
Facade contractor : SP FAB  
Completion By : OCT 2015







Project : SYNTEL TIRUNELVELLI  
Client : SYNTEL  
Architect : EDIFICE CONSULTANTS  
F1 System : Unitized System 3000 M2  
Facade contractor : SMA  
Completion By : OCT 2018



Project : COURTYARD MARRIOT HOTEL  
Client : MRG HOSPITALITY  
Architect : DESBUILD KRIS ASSOCIATED ARCH  
F1 System : Unitized System 11500 M2  
Facade contractor : HATIM GLAZING  
Completion By : OCT 2016







Project : ATMOSPHERE, KOLKATA  
Client : FORUM PROJECTS  
Architect : ARC STUDIO  
F1 System : Curtain wall ,Sliding System 22000 M2  
Facade contractor : GLASS WALL SYSTEM  
Completion By : OCT 2016





Project : LOTUS 101  
Client : ENPAR GROUP  
Architect : SKYLINE ARCHITECTS  
F1 System : Seamless Railing 7,800 M2  
Facade contractor : GLASS WALL SYSTEM  
Completion By : OCT 2017



FACADE **ONE**  
INTERNATIONAL

## Innovative Façade Solutions

INDIA | DUBAI | USA | SWITZERLAND

201, DOSTI PINNACLE, WAGLE INDUSTRIAL ESTATE THANE (WEST). MUMBAI  
+91-22-6767 3300 | [sales@facade1.com](mailto:sales@facade1.com) | [www.facadeone.com](http://www.facadeone.com)